

Model produktu	Z-23 A	
Format:	A4	Material:
		Polystyrene (PS)
Skala:	1:1	Tolerancja:
		+/- 0.1

H G B A

1

2

3

4

1

2

3

4



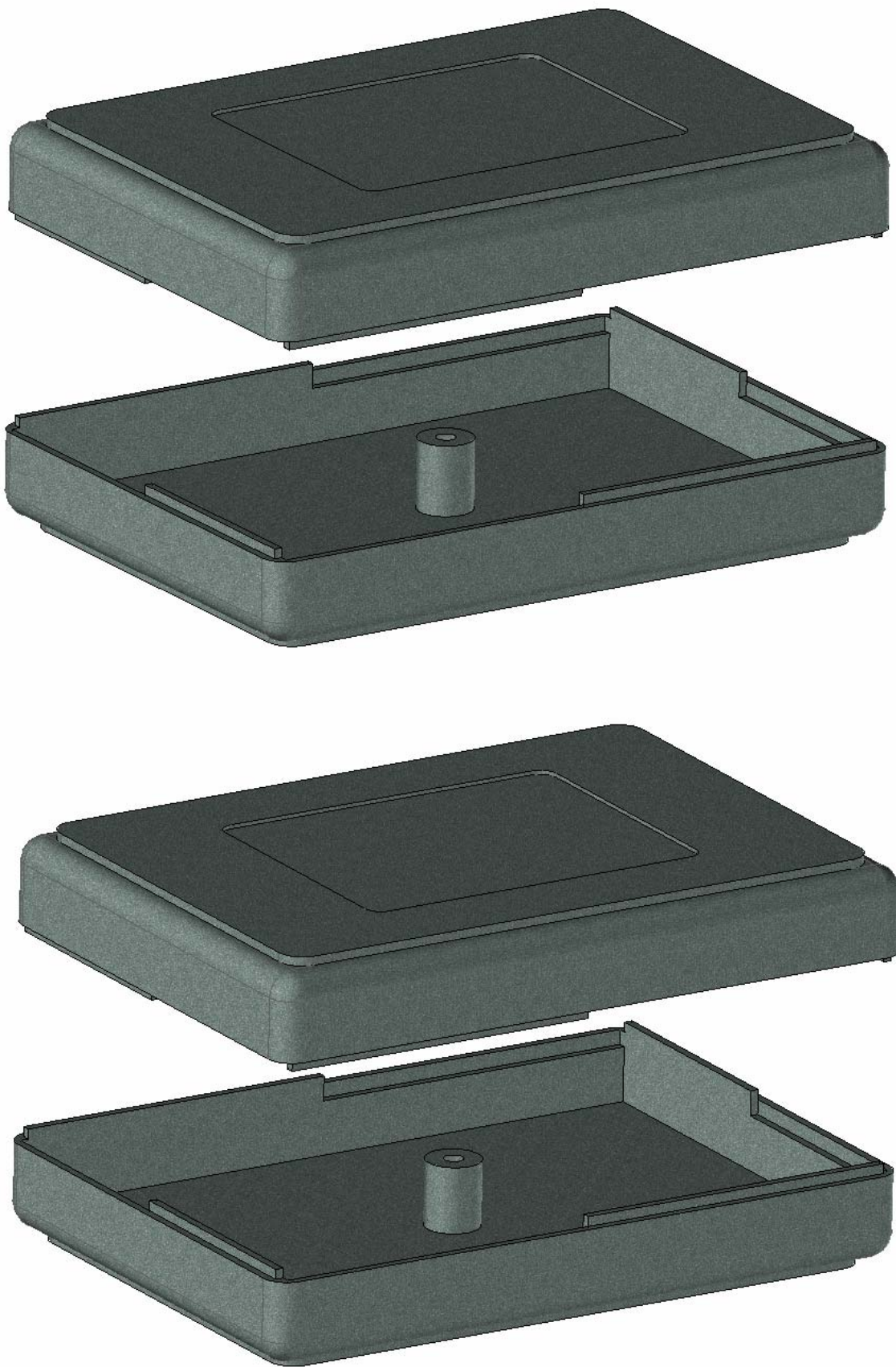



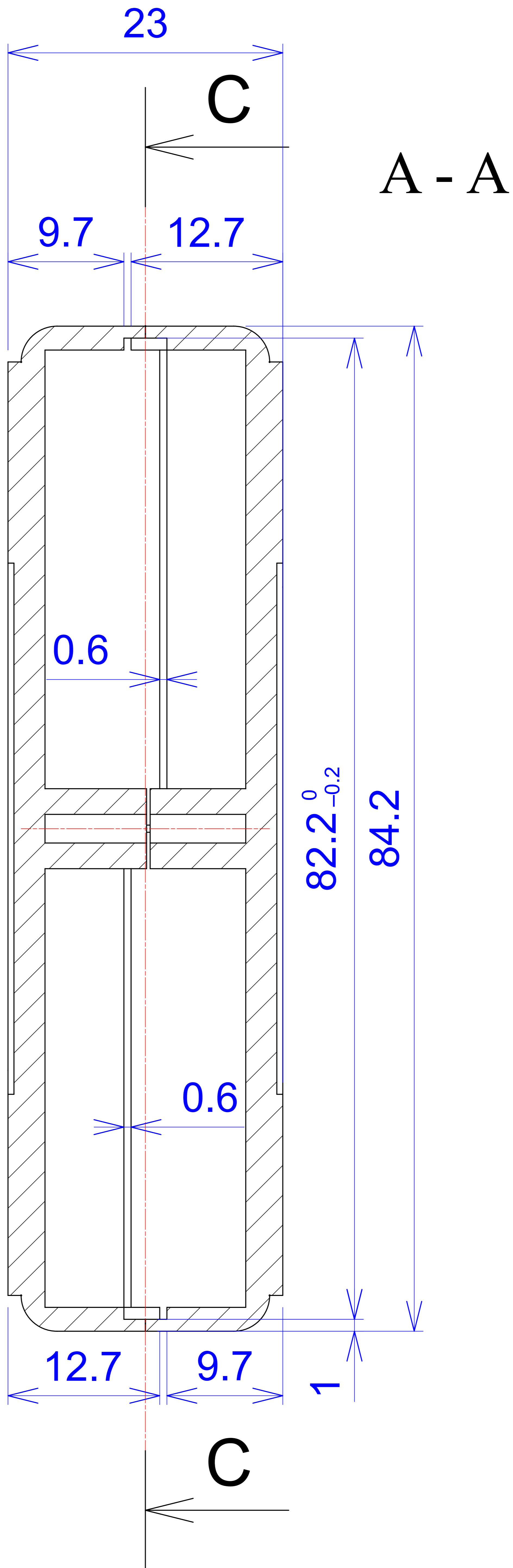

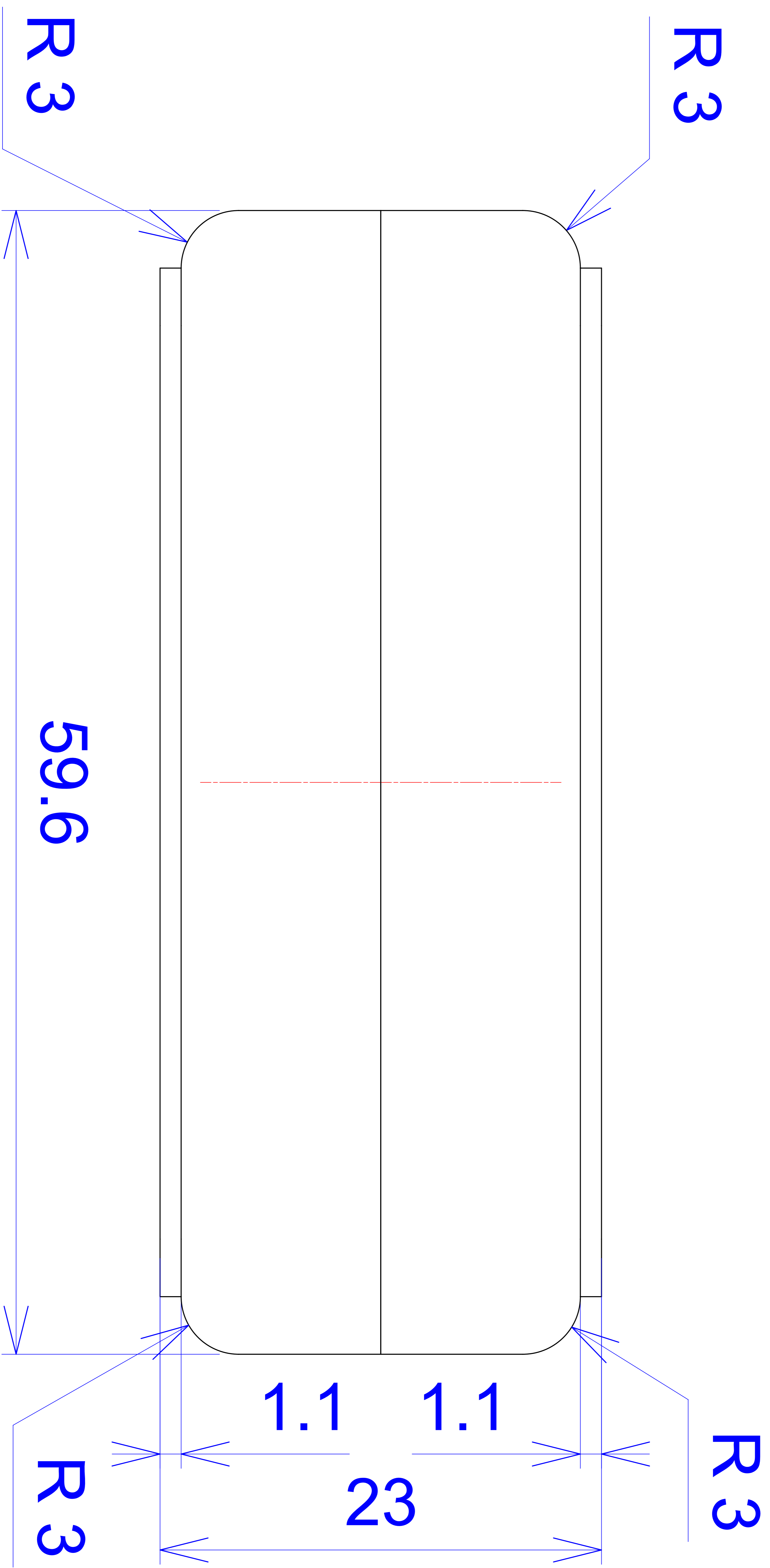

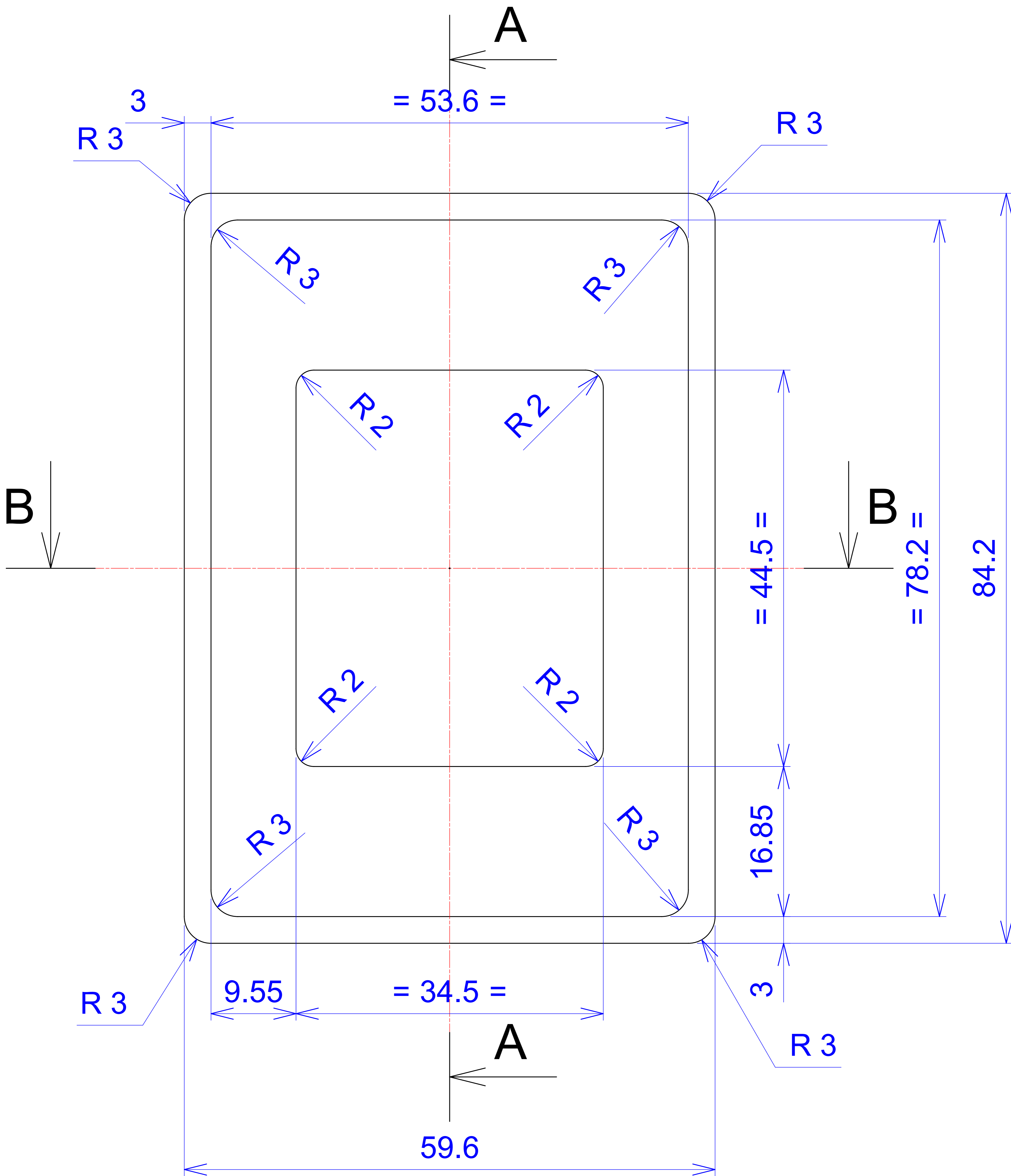

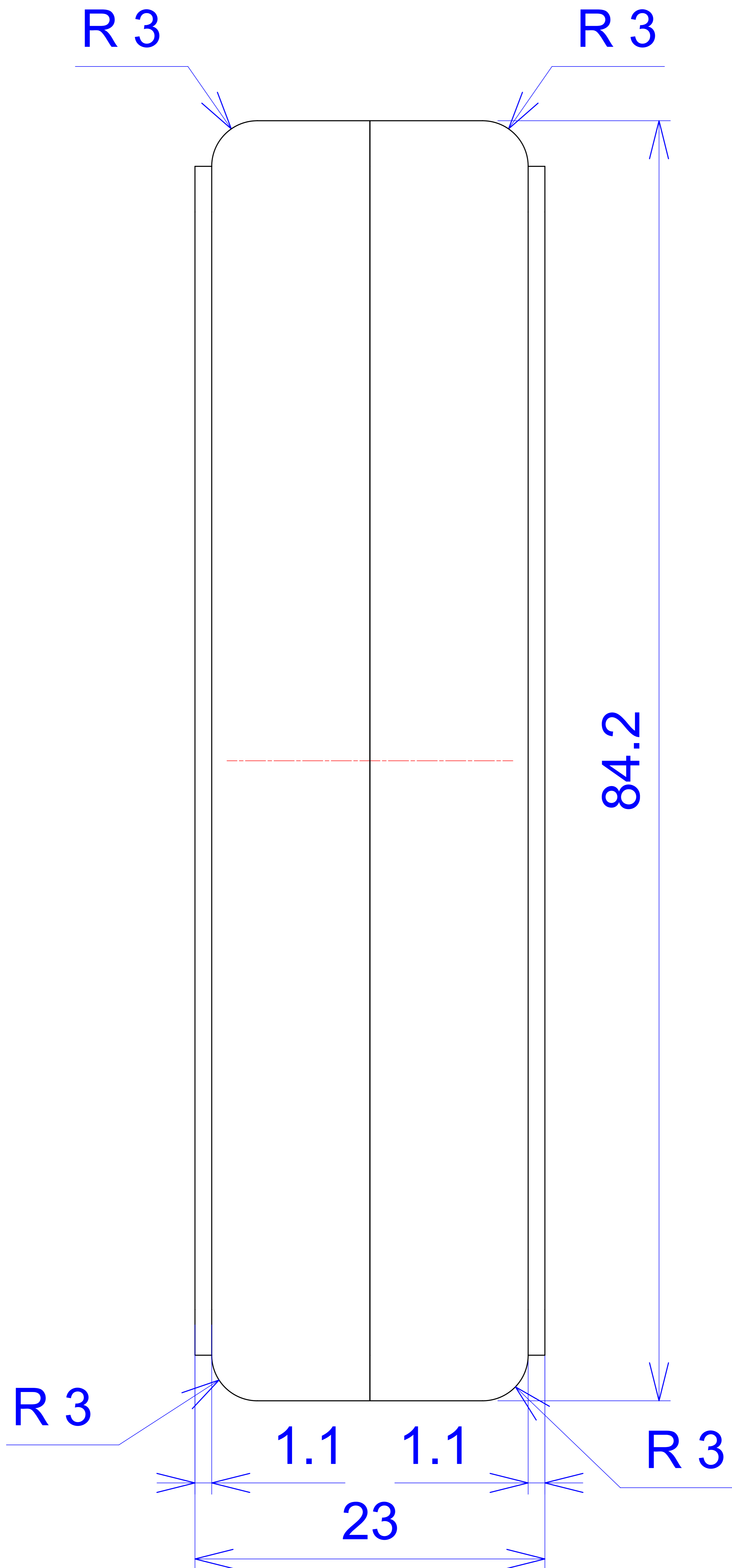

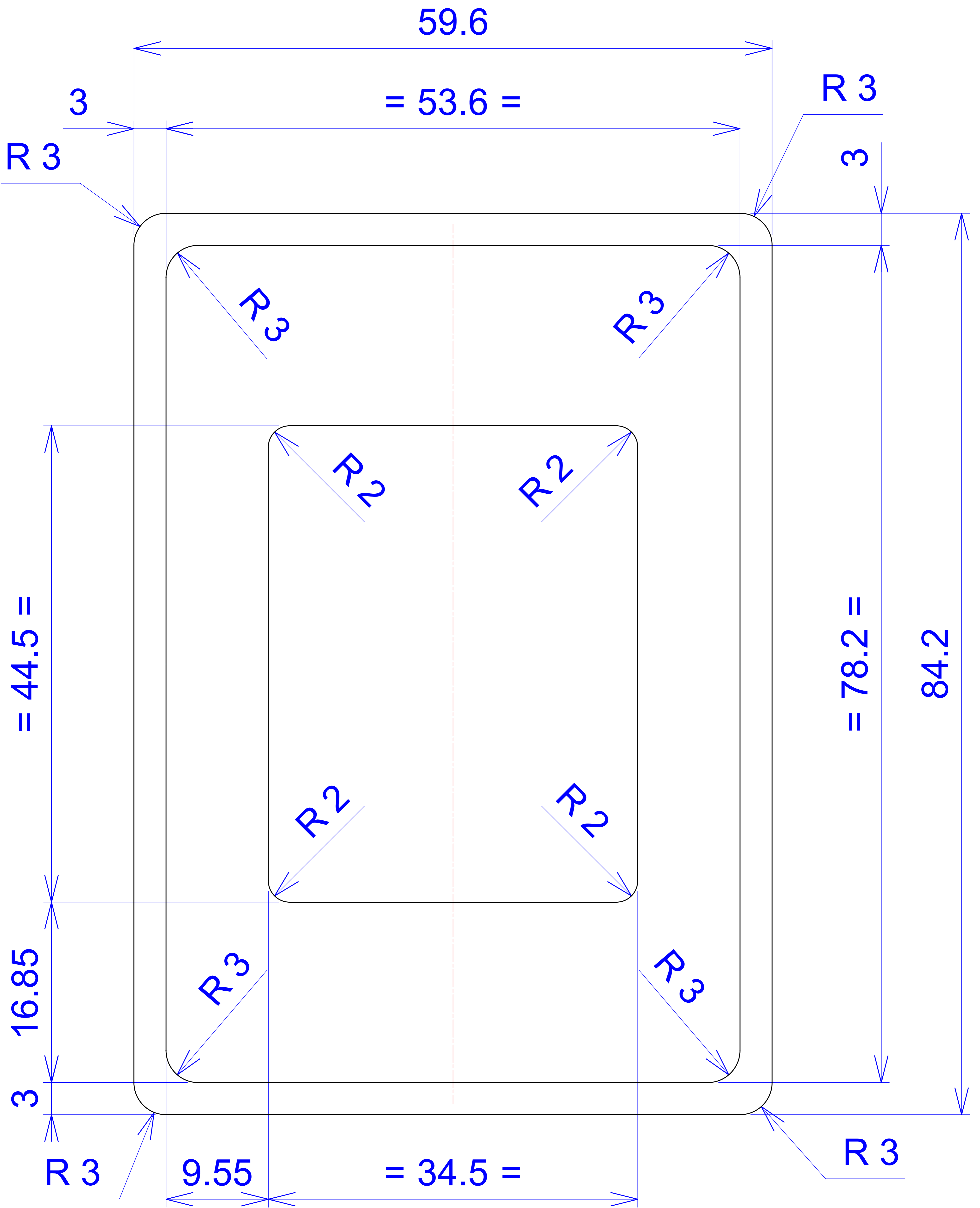

C - C

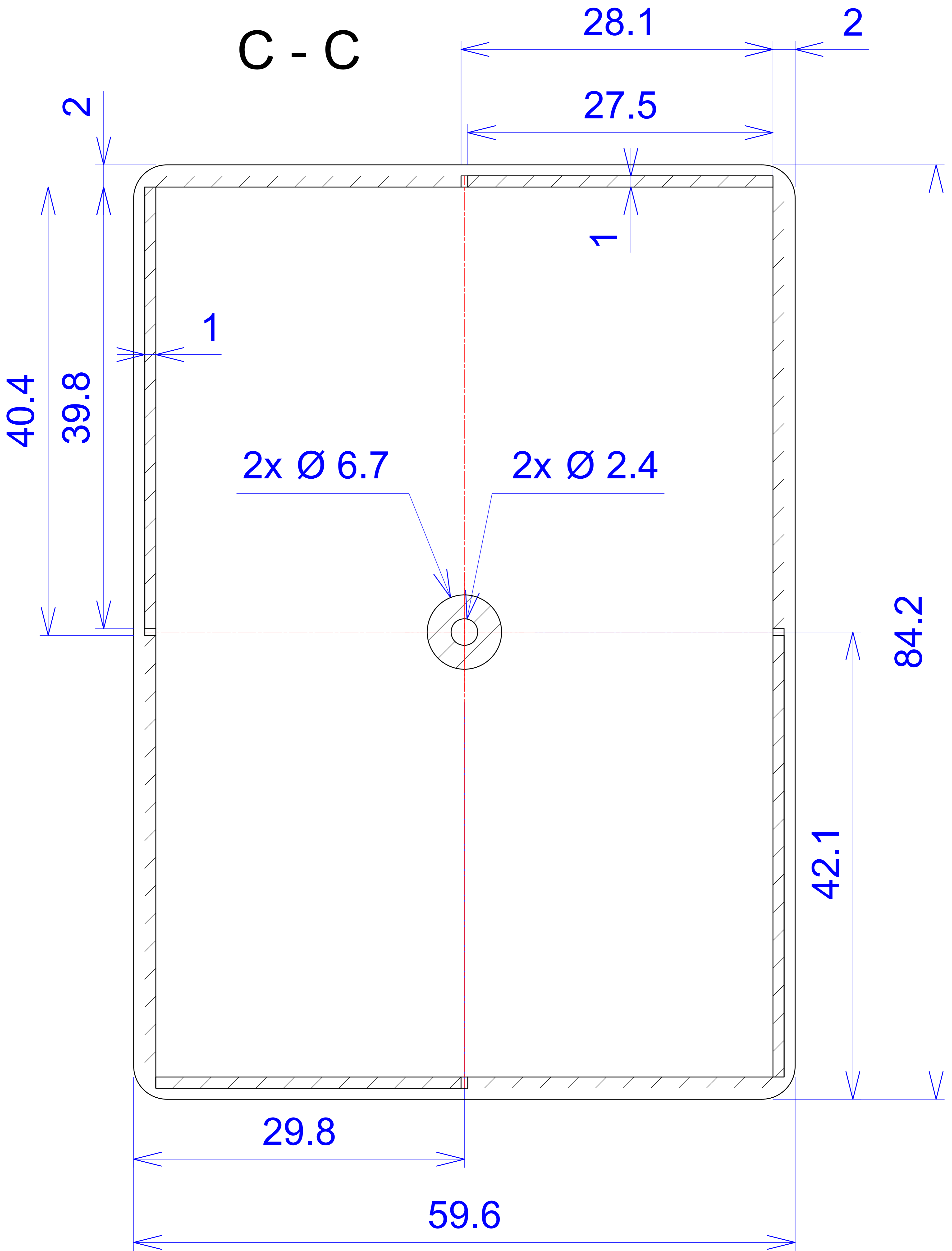

4x Ø 6.7

4x Ø 2.4

B - B

