

THIS DOCUMENT IS THE PROPERTY OF
KEYSTONE ELECTRONICS CORP. AND
SHALL NOT BE REPRODUCED, DISTRIBUTED
OR USED AS A BASIS FOR MANUFACTURE
WITHOUT PRIOR WRITTEN PERMISSION
FROM KEYSTONE ELECTRONICS CORP.

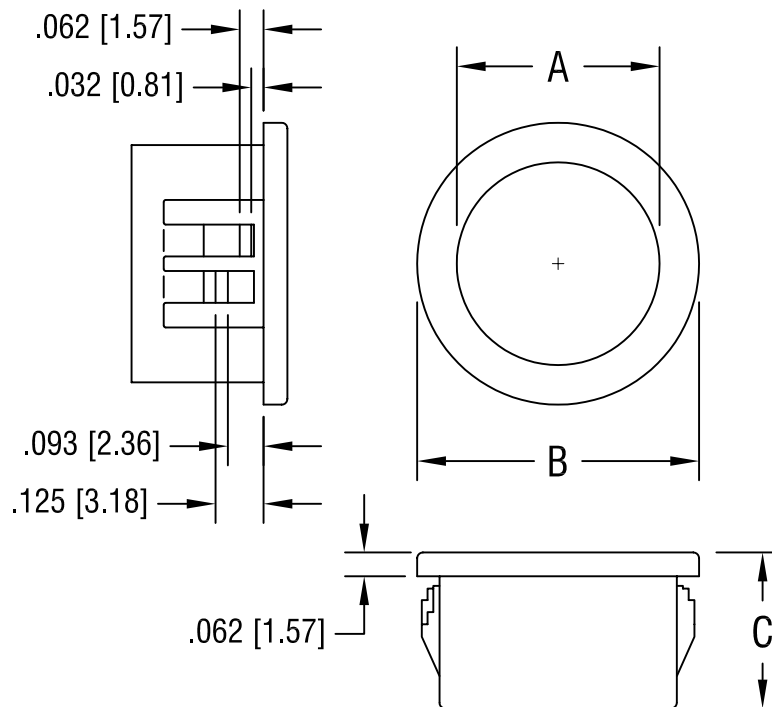

MOUNTING HOLE	'A' DIA.	'B' DIA.	'C' DIM.
.375 [9.5]	.250 [6.35]	.468 [11.89]	.406 [10.31]

KEYSTONE ELECTRONICS CORP.

ASTORIA, N.Y. 11105-2017

PART NAME

NYLON INSULATING BUSHING

MATERIAL

NYLON 6/6, BLACK UL 94V-2

FINISH

-

DRN BY

BOONE

DATE

11.3.06

APP'D

SCALE

NONE

TOLERANCES

INCH [MM]

DECIMAL $\pm .015$ [± 0.38]

ANGULAR $\pm 1^\circ$
UNLESS OTHERWISE SPECIFIED

CODE

C/M

DWG NO.

8472

DATE

DESCRIPTION

REV.