

THIS DOCUMENT IS THE PROPERTY OF
KEYSTONE ELECTRONICS CORP. AND
SHALL NOT BE REPRODUCED, DISTRIBUTED
OR USED AS A BASIS FOR MANUFACTURE
WITHOUT PRIOR WRITTEN PERMISSION
FROM KEYSTONE ELECTRONICS CORP.

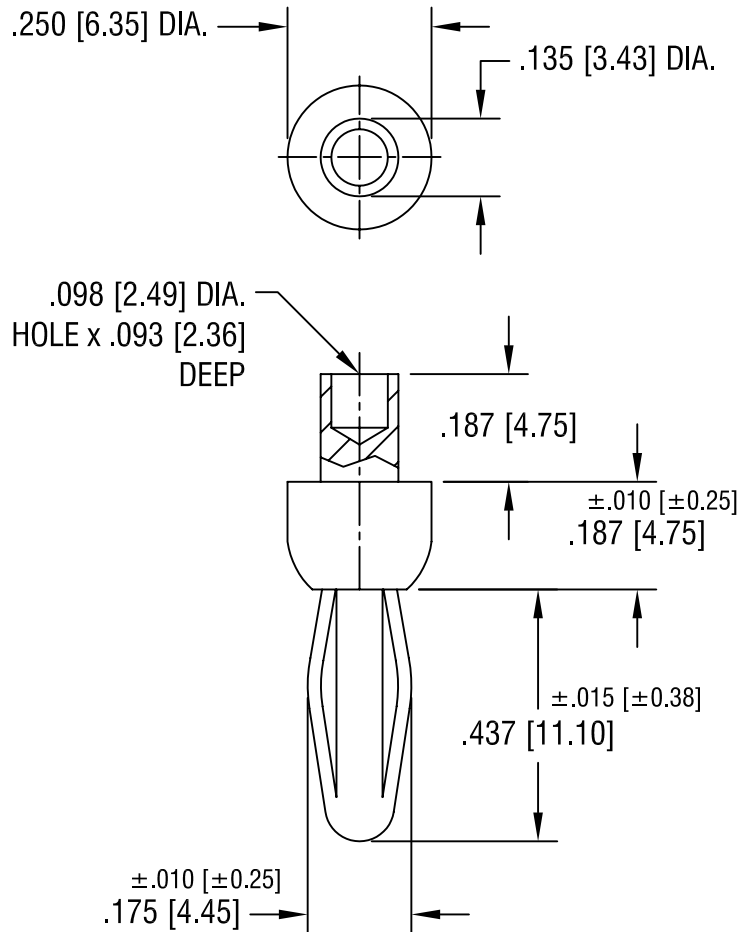

NOTES:

1. SPRING: MAT'L - BERYLLIUM COPPER
BODY: MAT'L - BRASS

KEYSTONE ELECTRONICS CORP.			
ASTORIA, N.Y. 11105-2017			
PART NAME			
STANDARD RIVET BANANA PLUG			
MATERIAL			
AS NOTED			
FINISH		DRN BY	DATE
NICKEL PLATE		BOONE	2.16.82
		APP'D	SCALE
			3X
TOLERANCES	INCH [MM]	CODE	DWG NO.
DECIMAL	±.005 [±0.15]	C	552-3
ANGULAR	± 1°		
UNLESS OTHERWISE SPECIFIED			

1.2.03	CHANGE AS PER ECN 03-001	D
DATE	DESCRIPTION	REV.