

THIS DOCUMENT IS THE PROPERTY OF
KEYSTONE ELECTRONICS CORP. AND
SHALL NOT BE REPRODUCED, DISTRIBUTED
OR USED AS A BASIS FOR MANUFACTURE
WITHOUT PRIOR WRITTEN PERMISSION
FROM KEYSTONE ELECTRONICS CORP.

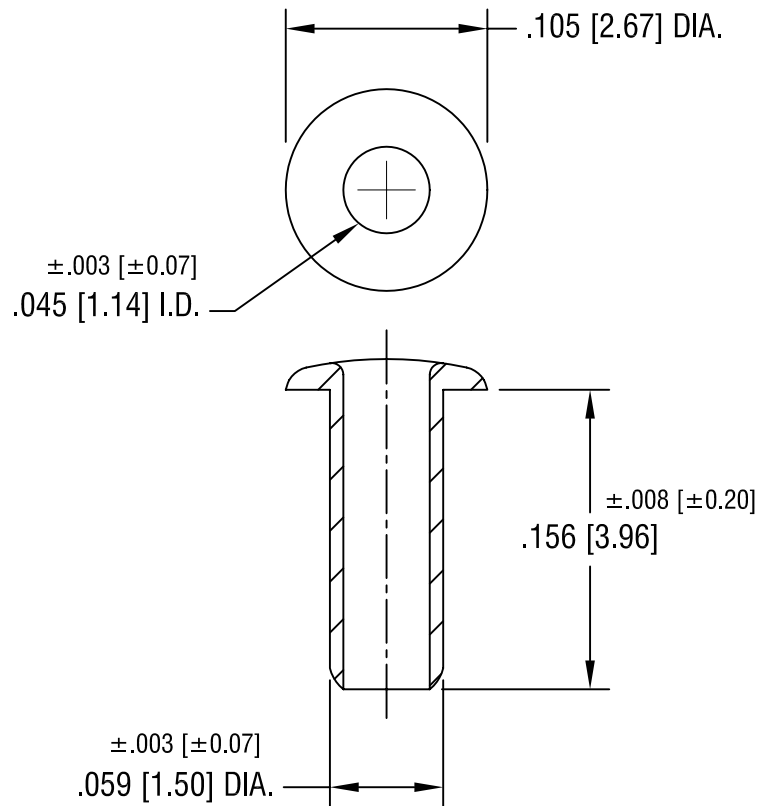

KEYSTONE ELECTRONICS CORP.			
ASTORIA, N.Y. 11105-2017			
PART NAME			
WIDE ROLL EYELET			
MATERIAL			
.007 [0.17] TH'K BRASS			
FINISH		DRN BY	DATE
TIN PLATE		BOONE	6.2.82
		APPD	SCALE
			10X
TOLERANCES	INCH [MM]	CODE	DWG NO.
DECIMAL	± .005 [± 0.15]	C/M	25
ANGULAR	± 1°		
UNLESS OTHERWISE SPECIFIED			

7.13.01	CHANGE AS PER ECN 01-049	A
DATE	DESCRIPTION	REV.