

HR1235W

Valve-regulated lead-acid battery



HIGH RATE SERIES

Characteristics

Nominal voltage	12V (6 cell per unit)	
Nominal power at 15 min. rate 1.67V/cell (25°C)	35W	
Capacity (25°C)	20 Hours rate/10.5V	9Ah
	5 Hours rate/10.5V	7.95Ah
Terminal type	T1/T2	
Torque	N/A	
Approx. internal resistance (25°C)	17.0 mΩ	
Dimensions	Length	151±1.5mm (5.94inch)
	Width	65±1mm (2.56inch)
	Height	94±1mm (3.70inch)
	Total height	100±1mm (3.90inch)
Design Life (stand-by)	JIS at 25°C	10 years
	Eurobat at 20°C	10-12 years
Weight	2.73kg (6.02lbs)±4%	
Nominal operating temperature	25±3°C (77°F±5)	
Operating temperature range	Discharge	-15°C~50°C (5°F~122°F)
	Charge	-10°C~50°C (14°F~122°F)
	Storage	-20°C~50°C (-4°F~122°F)
Float charging voltage at 25°C	13.6V~13.8V	
Cyclic charging voltage at 25°C	14.5V~15.0V	
Temperature compensation	Float charge	-18 (mV/°C/Block)
	Cycle charge	-30 (mV/°C/Block)
Max. charging current (A)	2.80A	
Max. discharge current for 5 seconds	135A	
Self discharge rate (25°C)	≤3%/month	
Battery container ABS UL94-HB	V-0 optional	

Overview

NPP Power High Rate series batteries are specially designed for applications that require high power output. With their high-power density and low internal resistance, the HR series are the right choice for your most demanding applications.

Dimensions & Terminal Type (mm)

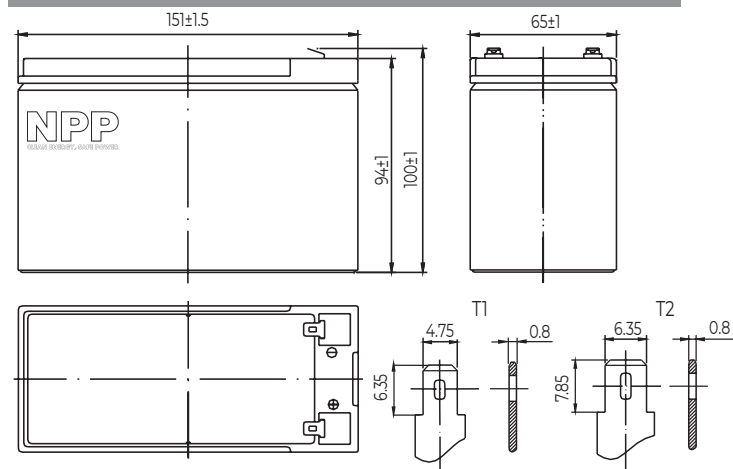

Certification & Compliances



Compliant to: EUROBAT, RoHS, WEEE's and Reach.
Manufactured according to IEC 60896-21 / 22

Construction

Component	Positive Plate	Negative plate	Container	Separator	Electrolyte	Safety valve	Terminal
Raw material	Lead dioxide	Lead	ABS (V-0 opt.)	AGM	Sulfuric Acid	Rubber	Copper

Constant current discharge characteristics at 25°C

(Ampere/cell)

F.V/Time	5min	10min	15min	20min	30min	45min	60min	2h	3h	4h	5h
1.60V/cell	42.5	25.7	18.69	14.80	12.22	7.49	5.92	3.31	2.35	1.89	1.62
1.67V/cell	38.8	24.6	18.06	14.17	11.82	7.25	5.78	3.28	2.33	1.87	1.61
1.70V/cell	35.9	23.9	17.53	13.86	11.60	7.12	5.68	3.26	2.32	1.87	1.60
1.75V/cell	32.7	22.9	17.01	13.44	11.32	6.94	5.57	3.21	2.30	1.85	1.59
1.80V/cell	30.8	21.5	16.06	12.94	10.91	6.68	5.40	3.13	2.23	1.80	1.55

Constant power discharge characteristics at 25°C

(Watts/cell)

F.V/Time	5min	10min	15min	20min	30min	45min	60min	2h	3h	4h	5h
1.60V/cell	76.8	47.9	36.8	28.4	20.4	14.5	11.5	6.58	4.72	3.80	3.27
1.67V/cell	72.6	45.7	35.5	27.3	19.7	14.2	11.2	6.52	4.68	3.77	3.24
1.70V/cell	70.0	44.5	34.5	26.7	19.4	14.0	11.0	6.48	4.66	3.75	3.22
1.75V/cell	66.4	42.6	33.4	25.8	18.9	13.7	10.8	6.39	4.63	3.73	3.20
1.80V/cell	60.8	40.3	31.6	24.4	18.2	13.5	10.5	6.22	4.49	3.61	3.11

The above characteristics represent average values and can be obtained within three charge and discharge cycles. The batteries must be fully charged before testing. The data in this document is subject to change without notice and become contractual only after written confirmation. Please contact NPP Power for the latest available version.

NPP Power (Vietnam) Co.,Ltd

Lot A22.3, Road C4, Thanh Thanh Cong Industrial Zone,
An Hoa Village, Trang Bang District, Tay Ninh Province,
Vietnam

Guangzhou NPP Power Co, Ltd.

No.67 Lianglong Road, Huashan Town, Huadu District,
Guangzhou, China
Email: info@nppower.com.cn Tel. +86 20 37887 390