

THIS DOCUMENT IS THE PROPERTY OF
KEYSTONE ELECTRONICS CORP. AND
SHALL NOT BE REPRODUCED, DISTRIBUTED
OR USED AS A BASIS FOR MANUFACTURE
WITHOUT PRIOR WRITTEN PERMISSION
FROM KEYSTONE ELECTRONICS CORP.

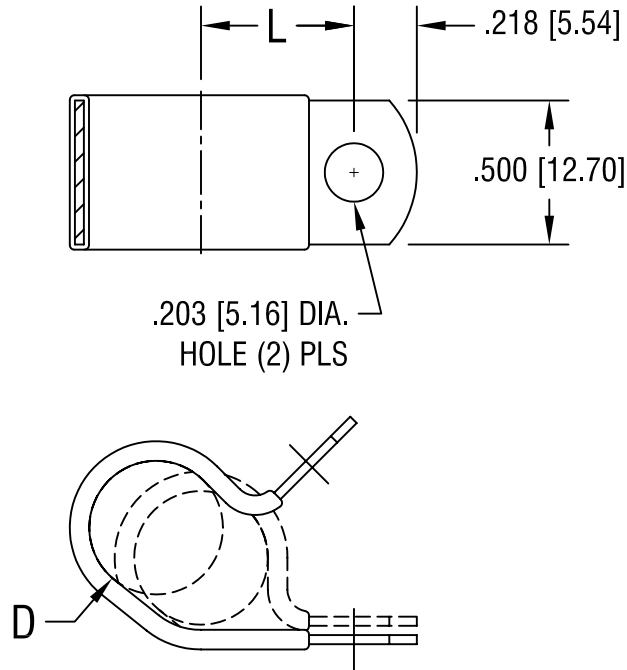

'L' DIM.	'D' FOR DIA.
.750 [19.05]	.875 [22.23]

KEYSTONE ELECTRONICS CORP.			
ASTORIA, N.Y. 11105-2017			
PART NAME			
INSULATED STEEL CABLE CLAMP			
MATERIAL			
.032 [.81] TH'K STEEL, BLACK VINYL			
FINISH		DRN BY	DATE
ZINC PLATE CLEAR CHROMATE		BOONE	10.20.99
		APP'D	SCALE
		LN	NONE
TOLERANCES	INCH [MM]	CODE	DWG NO.
DECIMAL	$\pm .010$ [± 0.25]	C/M	8132
ANGULAR	$\pm 1^\circ$		
UNLESS OTHERWISE SPECIFIED			

10.18.06	CHANGE AS PER ECN 06-070	A
DATE	DESCRIPTION	REV.