



Installer technical documentation

RFID reader

UW-U4R

UW-U4G

Documentation version: UW-U4-man-inst-ang-v6
Valid from version V6 of software



ATTENTION! THIS DOCUMENTATION IS OWNED BY NETRONIX SP. Z O.O. AND IS STRICTLY CONFIDENTIAL

DISTRIBUTION OF THE DOCUMENTATION IN ANY FORM WITHOUT PERMISSION OF THE OWNER IS STRICTLY FORBIDDEN

1.	INTRODUCTION	3
2.	DESCRIPTION OF HOUSING ELEMENTS	3
3.	Technical specifications	4
3.1.	Dimensions and distance between montage holes.....	4
4.	CONNECTING READERS OPERATING CLOSE TO EACH OTHER.....	5
5.	CONNECTING READERS OPERATING IN RS485 NETWORK	6
6.	Installer menu	7
6.1.	Entering installer menu.....	7
6.2.	Installer menu structure	7
6.3.	Types and set-up of the reader inputs/outputs	8
6.4.	Configuring input port.....	8
6.5.	Configuring output port	10
6.6.	Setting reader address in RS485 network	13
6.7.	Setting enter/exit times of alarm system	13
6.8.	Assigning installer rights.....	14
7.	Access control module	15
7.1.	Configuration.....	15
7.2.	Access control module blockade.....	15
8.	Alarm system module	15
8.1.	Configure	15
9.	External device module	15
10.	CLEARING CARD MEMORY AND RESTORING THE DEFAULTS	16

1 . Introduction

The UW-U4R and UW-U4G devices are RFID card readers of UNIQUE type.

They are designed to feature following functionality:

- Access control feature,
- Alarm system,
- External device controller.

The reader is equipped with RS-485 interface, by means of which many modules can be connected via one long bus. There is possible to hook up a set of readers via RS interface to AccessConfig master software installed on PC computer.

The reader is designed to allow configuring it fully without need to use PC software for it. After logging, access to all options and set-ups is possible by means of appropriate number of front panel key pressings. In this document are described subjects concerned to reader configuration only, without using of software. Manufacturer of readers recommends users to read carefully user documentation and installer documentation.

2 . Description of housing elements

Rear view

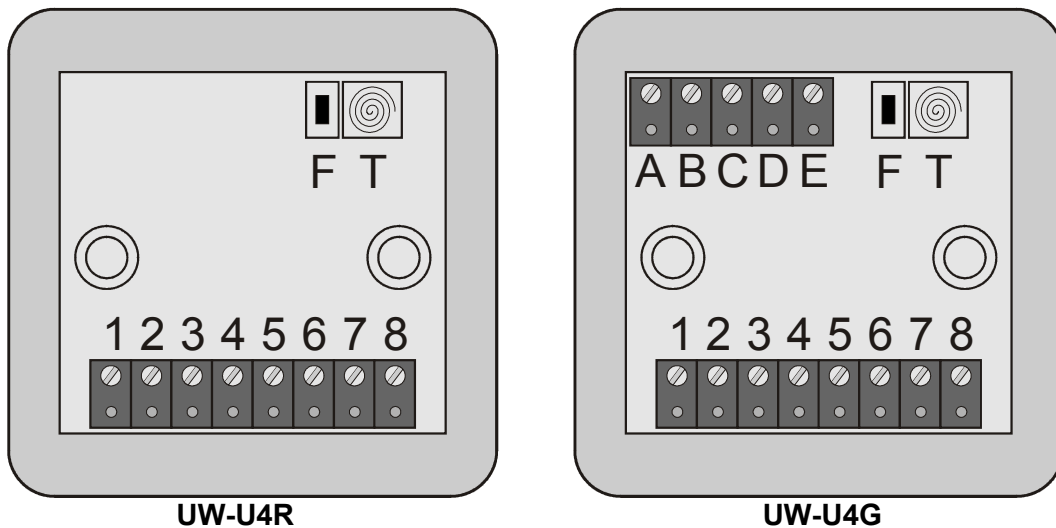

Indication in picture	Function performed
1	IO 1
2	Synchronization of two proximity readers
3	RS-485 pin A
4	RS-485 pin B
5	Plus of module supply voltage
6	Ground and minus supply voltage of module

7	Output of relay 1 contacts
8	Output of relay 2 contacts
T	Tamper with spring
A	IO 2
B	IO 3
C	IO 4
D	IO 5
E	IO 6

3. Technical specifications

Module UW-U4R/ UW-U4G parameters	
Supply voltage	7-16 V
Maximum current consumption	120 mA
Operation temperature	-20°C - +65°C
Humidity	15% - 95% RH
Protection level	IP65
Rated operation radio frequency of the module	125 kHz
Read-out distance of Unique transponders	up to 12 cm
Maximum current of OC type outputs	500 mA
Maximum total output current	2 A
RS-485 transmission parameters	2400, 4800, 9600, 19200, 38400, 57600, 115200 b/s, 8 data bits, 1 stop bit, no parity, conforms „Netronix Protocol“

3.1. Dimensions and distance between montage holes

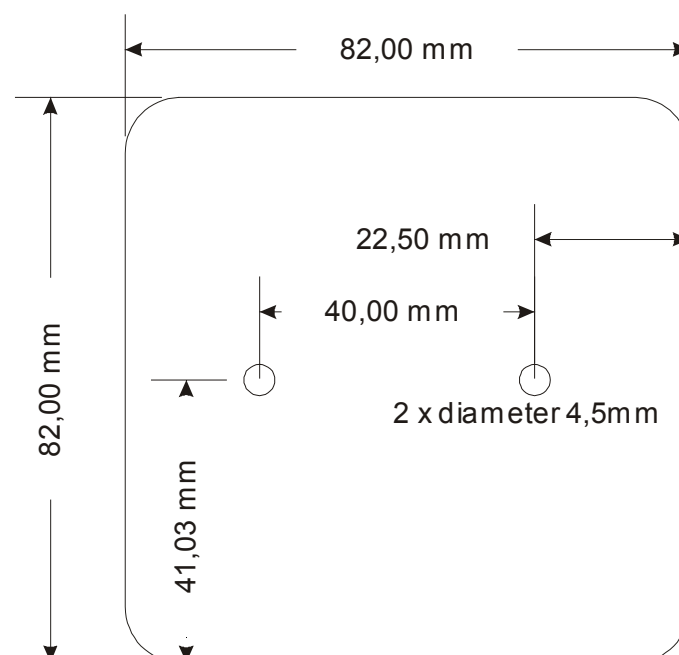

Front view

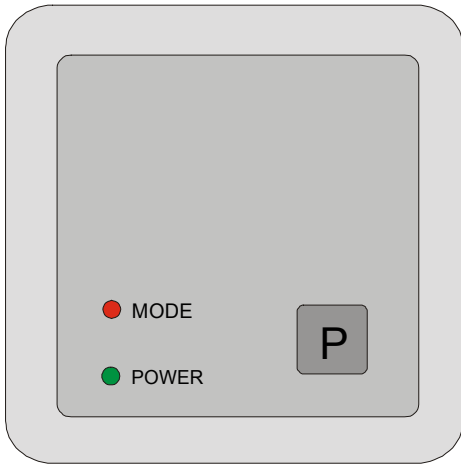

Indicator in the picture	Function performed
LED MODE	Tri-color LED Optical mode warning / configurable
LED POWER	Optical supply warning
P	Front key

The Mode LED and internal buzzer are used for informing a user on state, in which the reader currently is. Additionally, it is possible to change configuration, which will force extra responses of the indicators. These extra responses can modify by means of port configuration settings.

4. Connecting readers operating close to each other

The readers, which operate close to each other (with distance not higher than 50 cm) should be connected by means of synchronize link. Such connection provides the readers do not generate electromagnetic field in the same time.

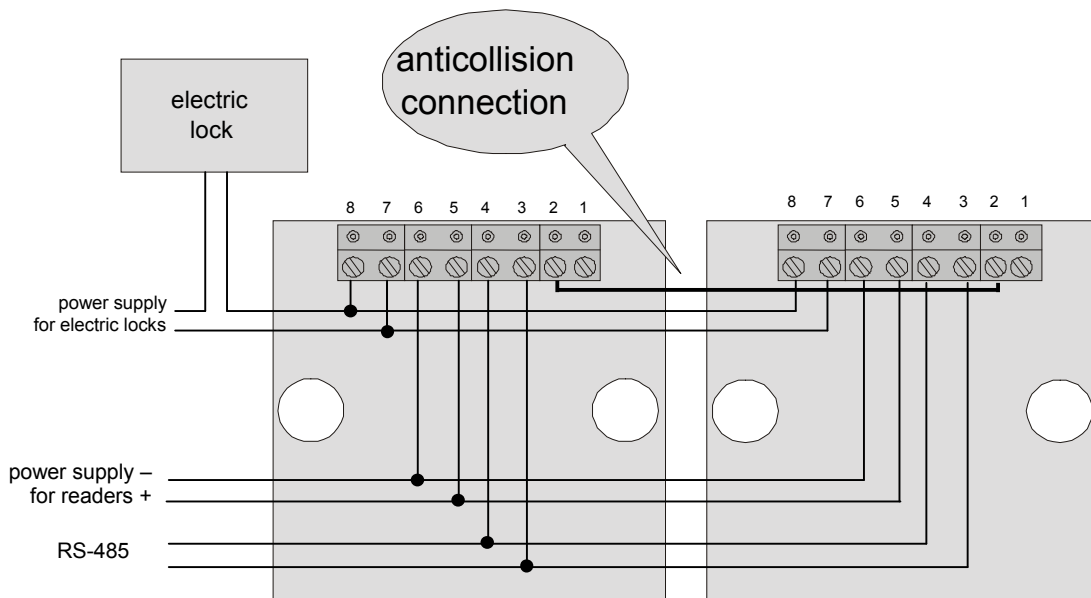

two readers with distance smaller than 20 cm

5. Connecting readers operating in RS485 network

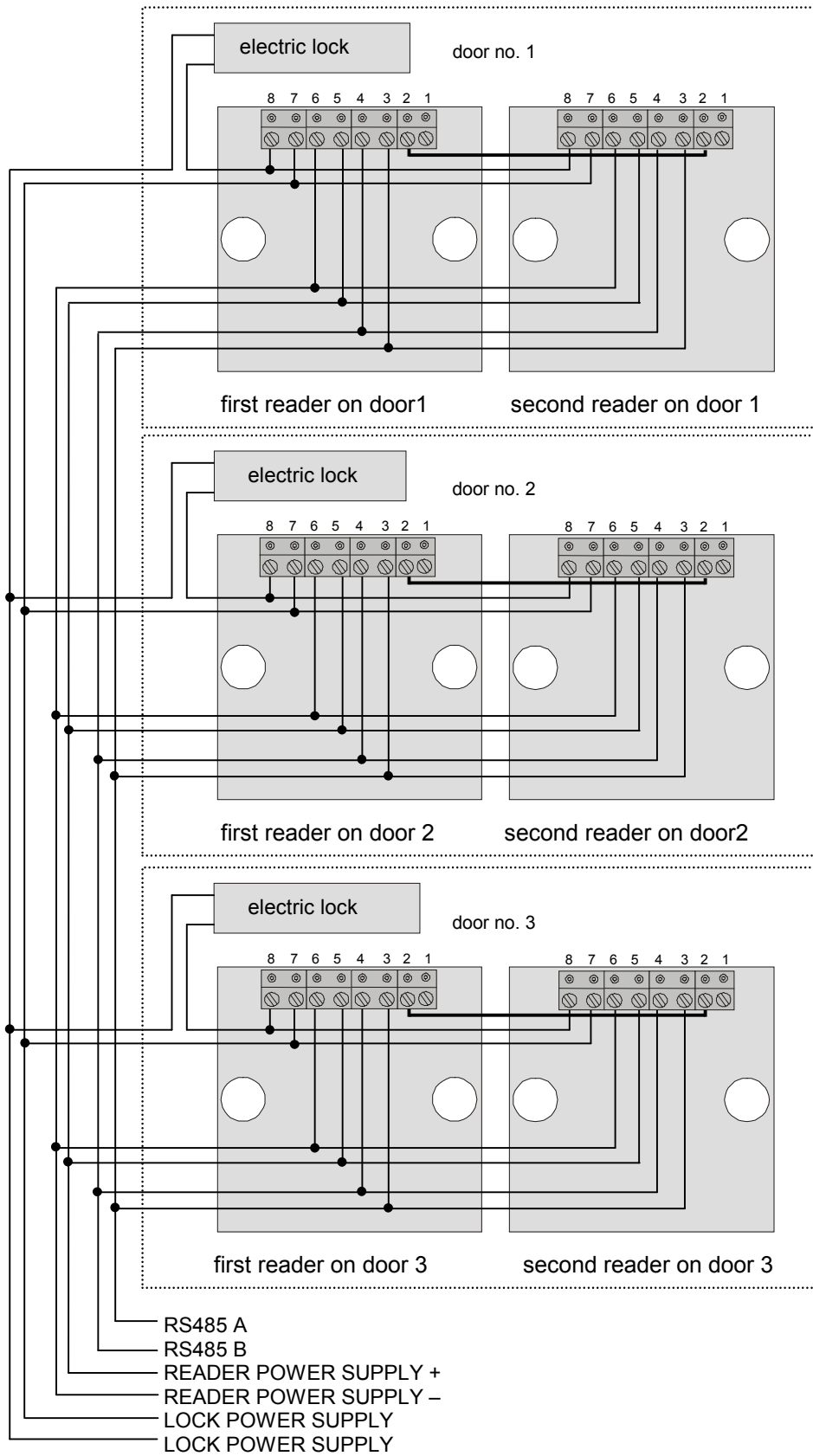



6. Installer menu

General foundations of menu functioning are described in user documentation.

Input to installer menu:

6.1. Entering installer menu

To enter the installer menu:

- enter master menu applying card with *master* right,
- select option „9” by means of push-button sequence: 9  ,
- apply the card with *installer* rights.

6.2. Installer menu structure

In installer menu, there are available the following options:

No.	Option name	Description
1	Electric input	Configuring type and parameters of electric inputs
2	Electric output	Configuring type and parameters of electric outputs
3	Reader address	Configuring address of a reader in RS485 bus
4	Alarm timings	Configuring enter and exit time of alarm system
5	Installer rights	Assigning installer rights
10	Output	Main menu exit

6.3. Types and set-up of the reader inputs/outputs

The reader provides free possibility to assign functions to general-purpose inputs/outputs. Input/output configuration is based on assigning proper function (with parameters) to each port.

INDEX OF AVAILABLE PORTS, WHICH WE CAN CONTROL IN UW-U4R		
PORT	Direction	Description
00	input	Key located in front panel of the reader
01	input/output	IO1
02	output	Green LED
03	output	Red LED
04	output	Buzzer
05	output	Relay
06	output	Blue LED
07	input	Tamper switch
AUXILIARY PORTS FOR UW-U4G VERSION		
08	input/output	IO2
09	input/output	IO3
10	input/output	IO4
11	input/output	IO5
12	input/output	IO6

6.4. Configuring input port

If we want to change the input configuration in relation to default settings described later on in this documentation, create configuration frame according to tables below and input it to the reader memory as described it in examples.

Table below shows input configuration frame:

Port No.		Output type		TRIGGER	DELAY		
0-12		0-12		0-3	0-255		
1st digit	2nd digit	1st digit	2nd digit	1st digit	1st digit	2nd digit	3rd digit



where:

Parameter name	Parameter description	Value range
Port No.	Number of I/O port, which is to be configured, see table: port index	00-07 for UW-U4R 00-12 for UW-U4G
Output type	Establishes input type, see table of input types	00-12
TRIGGER	A byte, which establishes input trigger method	0x00 no invert type 0x01 invert type 0x02 response for positive slope 0x03 response for negative slope
DELAY	Establishes time duration of physical signal on input, which is required to enable the input	0-255 for input of OpenDoorSensor type 0 for inputs of other types













INPUT TYPE TABLE		
No.	Name	Function
00	PermanentlyOff	Always retrieves "0"
01	PermanentlyOn,	Always retrieves "1"
02	OpenDoorSensor,	Open door sensor
03	OpenDoorButton,	Opening door push-button
04	CounterReadClear,	Input of input positive slope counter
05	HumanAttackButton	Panic push-button input
06	ResetOfAlarm	All alarm reset input
07	DeviceControl	Input for controlling the auxiliary device
08	AccesBlockade,	Input for blocking the access control module
09	ArmOfAlarmSystem	Input for arming the alarm system
10	DisarmOfAlarmSystem	Input for unarming the alarm system
11	DelaySensor	Input of slow line of alarm system (for sensor with delay)
12	ImmediateSensor	Input of fast line of alarm (for sensor with no delay)





 *Input configuration example:*

To configure input IO3 (index 9) as open door sensor (type 2), which causes system activation after 15 seconds:

- go to installer menu, see section 6.1,
- be sure to be in INSTALLER menu,
- enter option '1' (electric input set-up) by means of push-button sequence 1  ,
- input confirmation frame showed below,

No. of port		Input type		TRIGGER	Hold-UP		
9		2		0	150		
0	9	0	2	0	1	5	0

by means of push-button sequence: ; **9**  ; ; **2**  ; ; **1**  ; **5**  ; 

- correct sequence input will be confirmed by short double beep,
- enter master menu by means of push-button sequence 10  ,
- exit master menu by means of push-button sequence 10  .

6.5. Configuring output port

If we want to change an output configuration in relation to default settings described later on in this documentation, create configuration frame according to tables below and input it to the reader memory as described it in examples.

The IO1-IO6 terminals are outputs of open collector (open drain) type with current capacity of 500 mA. Output module is outfitted with over-current protection, which switches outputs of in case of excessive current, and switches them on again in case current drops below threshold value.

Table below shows output configuration frame:

Port No.		Output type		ConfByte1		Hold-UP			0 Time			1 Time		
0-12		0-12		0-15		0-255			0-255			0-255		
1st digit	2nd digit	1st digit	2nd digit	1st digit	2nd digit	1st digit	2nd digit	3rd digit	1st digit	2nd digit	3rd digit	1st digit	2nd digit	3rd digit

INPUT TYPES TABLE		
No.	Name	Function
00	PermanentlyOff	Always retrieves "0"
01	PermanentlyOn,	Always retrieves "1"
02	SerialAutoLow,	Outputs for controlling by RS485, which state returns to „0" automatically
03	Serial,	Output controlled via RS485
04	OpenDoorLock,	Output for controlling the access control magnetic lock
05	AnyCard	Output enabled after applying any card
06	BlockadeIndicator	Output of access control blockade indicator
07	OpenDoorAlarm	Output of open door alarm
08	DeviceControl	Output for controlling auxiliary device
09	HumanAttackAlarm	Panic alarm output
10	AlarmSystemAlarm	Alarm output of alarm system
11	ArmIndicator	Output of alarm arming indicator
12	DoorAttackAlarm	Tripped door alarm output

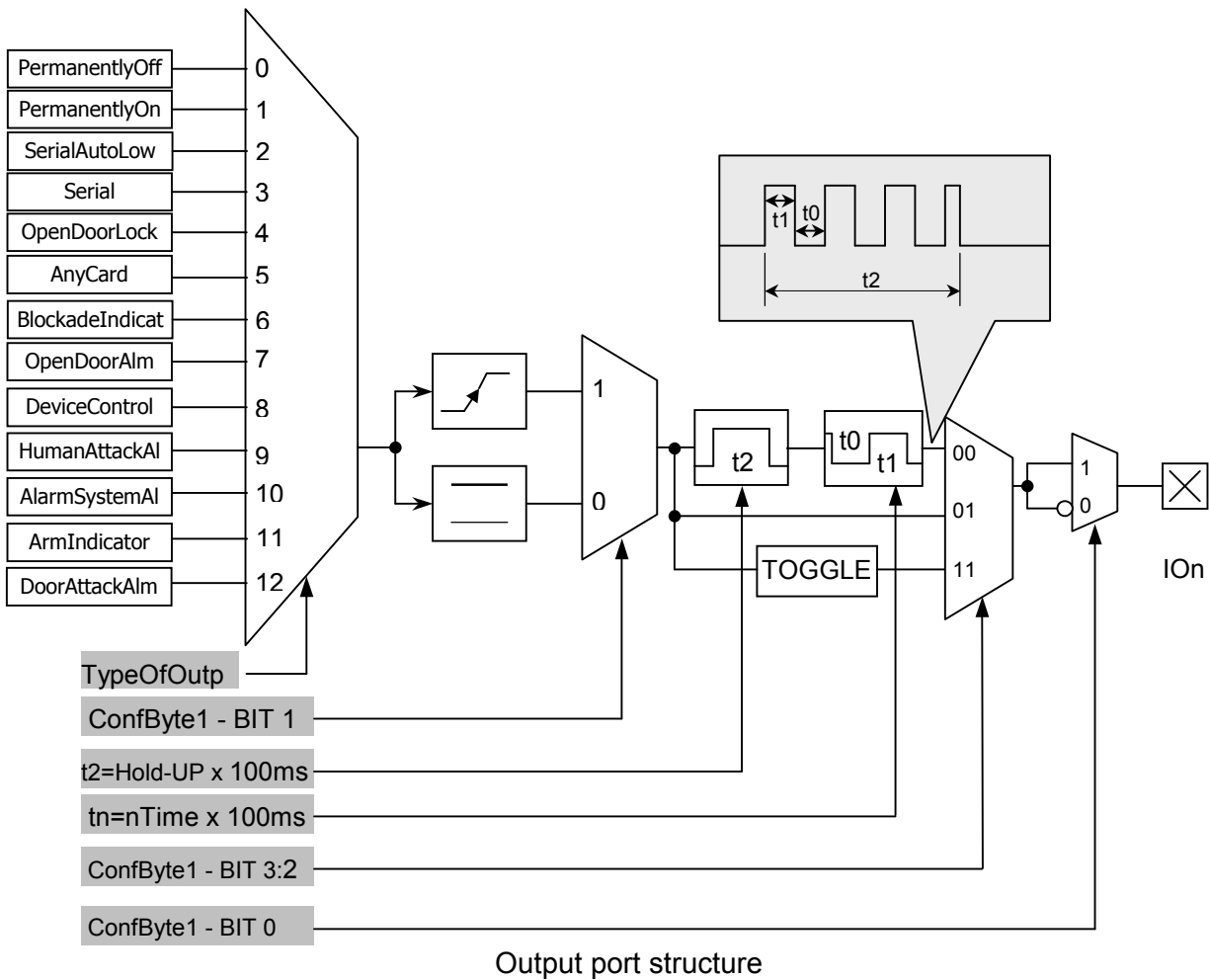

Output port structure

where:

Parameter name	Parameter description	Value range
Port No.	Number of I/O port, which is to be configured, see table: port index	00-07 for UW-U4R 00-12 for UW-U4G
Output type	Control signal source	00-12
ConfByte1	Single byte, in which: BIT0 establishes output type as normally open or normally closed. BIT 1 determines response method of given output as a responding for actuation change (slope sensitive) or responding for actuation state (state sensitive). BIT 3:2 determines method of output behavior in relation to trigger signal state.	ConfByte1 Bit 0: 0 - normally closed 1 - normally open ConfByte1 Bit 1: 0 - level sensitive 1 - slope sensitive ConfByte1 Bit 2: 00 - rectangular wave generator 01 - directly 11 - toggle
HoldUP	Hold-up time of enable state, after actuation goes off. The time is expressed as a: hold-up x 100 ms. During hold-up it is possible to configure	000-255

	an output, which is able to generate rectangular wave.	
0Time	Time of generator logic zero	000-255
1Time	Time of generator logic one	000-255

Output configuration example 1:

To configure relay output as a relay output (index 05) controlled by means of access control magnetic lock (type 04) with enable time duration equal to 3.5 sec:

- go to installer menu, see section 6.1,
- be sure to be in INSTALLER menu,
- enter option '2' (configuring electric output) by means of push-button sequence 2 ,
- input output configuration frame showed below,

Port No.		Output type		ConfByte1		Hold-UP			0 Time			1 Time		
5		4		01		35			0			35		
0	5	0	4	0	1	0	3	5	0	0	0	0	3	5

using following push-button sequence:

; 5 ; ; 4 ; ; 1 ; ; 3 ; 5 ; ; ; ; ; 3 ; 5 .

- correct entering of the sequence will be confirmed with double short beep,
- enter master menu using push-button sequence 10 ,
- exit master menu using push-button sequence 10 .

Output configuration example 2:

To configure output IO2 (index 8) as a open door alarm signal (type7) in form of generated rectangular wave with time duration of 10 seconds and pulse with of 300 ms:



- go to installer menu, see section 6.1,
- be sure to be in INSTALLER menu,
- enter option '2' (configuring electric output) using push-button sequence 2 ,
- input an output configuration frame showed below.

Port No.		Output type		ConfByte1		Hold-UP			0 Time			1 Time		
8		7		1		100			3			3		
0	8	0	7	0	1	1	0	0	0	0	3	0	0	3

using following push-button sequence:

; 8 ; ; 7 ; ; 1 ; 1 ; ; ; ; ; 3 ; ; ; 3 .

- correct input of the sequence will be confirmed with double short beep,
- enter master menu using push-button sequence 10 ,

- exit master menu using push-button sequence 10  .

6.6. Setting reader address in RS485 network











In case of readers connected to operate in RS-485 bus network, it is required to assign to the readers unique numbers from range 001 to 254.

Configuration frame to set reader address:

Reader address		
range 001-254		
1st digit	2nd digit	3rd digit

 *Reader address setting example:*

To set reader address for 023:

- go to installer menu, see section 6.1,
- be sure to be in INSTALLER menu,
- enter option '3' (reader address set-up) using push-button sequence 3  ,
- input push-button sequence: ; 2  ; 3  ,
- correct input of the sequence will be confirmed with double short beep,
- enter master menu using push-button sequence 10  ,
- exit master menu using push-button sequence 10  .

6.7. Setting enter/exit times of alarm system

Enter/exit times refer to response of sensors connected to input of *DelaySensor* type. These times are used during arming and disarming of alarm system. So:

- Sensors connected to input *DelaySensor* type are not taken into consideration during unarming of alarm system for time „**ENTER TIME**”.
- Sensors connected to input *DelaySensor* type are not taken into consideration during arming of alarm system for time „**EXIT TIME**”.















Configuration frame for setting of enter/exit times:

ENTER TIME			EXIT TIME		
time in seconds from 0-255 range			time seconds from 0-255 range		
1st digit	2nd digit	3rd digit	1st digit	2nd digit	3rd digit

 *An example of enter/exit times setting for alarm system:*







To set enter time for 20 seconds and set exit time for 15 seconds:

- go to installer menu, see section 6.1,

- be sure to be in INSTALLER menu,
- enter option '4' (alarm timings) using push-button sequence 4  ,
- input push-button sequence: ; 2  ; ; ; 1  ; 5  ,
- correct input of the sequence will be confirmed with double short beep,
- enter master menu master using push-button sequence 10  ,
- exit master menu using push-button sequence 10  .

6.8. Assigning installer rights

The „*INSTALLER*” user option can be created by installer with master rights assigned only. To add „*INSTALLER*” rights to a card, which does not have them:

- apply card with MASTER and INSTALLER rights, to enter MASTER menu
- enter option '9' using push-button sequence 9  ,
- apply the card with MASTER and INSTALLER rights again,
- be sure to be in INSTALLER menu,
- enter option '5' using push-button sequence 5  ,
- enter card, to which we want to add the rights,
- operation completed successfully will be confirmed double beep,
- exit master menu using push-button sequence 10  .

7. Access control module

7.1. Configuration

For proper operation module requires:

- to register given user cards from „ACCESS CONTROL” category,
- to configure outputs of „OPENDOORLOCK” type – this signal is by default routed to relay, red LED and BUZZER for three seconds,
- in case of need, to configure input for open door sensor,
- in case of need, to configure push-button for door opening.

7.2. Access control module blockade

There is possibility to block access control module. To do this, apply card with „ACCESS BLOCKADE” rights. Blockade state indicates slow blinking of red and blue LED's. To unblock control module access, use „ACCESS BLOCKADE” card again.

8. Alarm system module

8.1. Configure

For proper operation, the alarm system module requires:

- to register user cards of „ACCESS CONTROL” category,
- to register user cards of „ALARM SYSTEM” category,
- to configure inputs of „DelaySensor” type – for slow sensors (acting with delay) operating with regard to enter/exit times,
- to configure inputs of „ImmediateSensor” type – for fast sensors (acting immediately),
- to configure outputs of „AlarmSystemAlarm” type – for devices signaling alarm tripping e.g. siren,
- in case of need, to configure alarm reset input of „ResetOfAlarm” type,
- in case of need, to configure alarm arm input of „ArmOfAlarmSystem” type,
- in case of need, to configure alarm unarm input of „DisarmOfAlarmSystem” type,
- in case of need, to configure alarm arm indicator input of „ArmIndicator” type,
- in case of need, to change enter/exit time settings, which by defaults are 10/10 seconds.

Operation of alarm system is described in user documentation.

9. External device module

Due to external device control module, it is possible to enable or disable any device connected to one of I/O outputs of the reader and make sure the current for given input does not exceed the limit.

For proper operation, the module requires:

- to register cards of „*DEVICE CONTROL*” category users,
- to configure inputs (outputs) of „DeviceControl” type,
- additionally, it is possible to configure input of „DeviceControl” type, which controls the output.

10. Clearing card memory and restoring the defaults

To restore defaults, push and hold for ca. 5 seconds the key “F” located on rear panel of housing. During restoring the defaults, following parameters of the reader are fixed:

Parameter name or functionality	Value or setting
Address on serial bus	0x01
Baud rate on serial bus	9600 bps
Total internal memory of transponders including Master card	0xff ff ff ff ff, it means memory clear
Access password	0x31 32 33 34 00 it means „1234” in character notation
Port 0 – front key	Common purpose input
Port 1 – IO1	Common purpose input
Port 2 – green LED	Common purpose
Port 3 – red RED	Magnetic lock enable warning
Port 4 – buzzer	Magnetic lock enable warning
Port 5 – relay	Magnetic lock enable warning
Port 6 – blue LED	Common purpose
Port 7 – IO2	Common purpose input
Port 8 – IO3	Common purpose input
Port 9 – IO4	Common purpose input
Port 10 – IO5	Common purpose input
Port 11 – IO6	Common purpose input
Master card	No Master card in card memory

Latest news on products of:

<http://www.netronix.pl/>