

































MULTI CONNECTION SYSTEM **MIDI**

Male Connectors with **CAGE CLAMP®**, Pin Spacing 5.08 mm / 0.2 in

<p>Pin spacing 5.08 mm/0.2 in, orange 0.08 – 2.5 mm² AWG 28 – 12 250 V/4 kV/3 300 V, 15 A  12 A 300 V, 15 A </p> <p> 8 – 9 mm / 0.33 in</p> <p>*        </p>	<p>Pin spacing 5.08 mm/0.2 in, orange 0.08 – 2.5 mm² AWG 28 – 12 250 V/4 kV/3 300 V, 15 A  12 A 300 V, 15 A </p> <p> 8 – 9 mm / 0.33 in</p> <p>*        </p>	<p>Pin spacing 5.08 mm/0.2 in, orange 0.08 – 2.5 mm² AWG 28 – 12 250 V/4 kV/3 300 V, 15 A  12 A 300 V, 15 A </p> <p> 8 – 9 mm / 0.33 in</p> <p>*        </p>
--	--	--

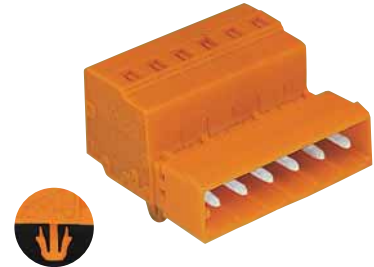
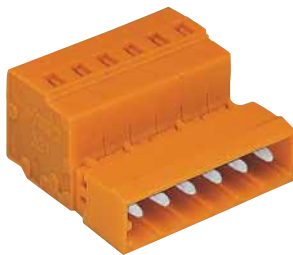

No. of poles	Item No.	No. of poles	Item No.	No. of poles	Item No.
Male connectors with CAGE CLAMP®, orange		Male connectors with CAGE CLAMP® and fixing flanges, orange, for screw fixing or similar methods of fixing, for vertical or horizontal fixing		Male connectors with CAGE CLAMP® and snap-in mounting feet, orange, for plate thickness 0.6 mm – 1.2 mm, fixing hole Ø 3.5 mm (with mounting adapter 209-137 for DIN 35 rail)	
2	231-632	2	231-632/019-000	2	231-632/018-000
3	231-633	3	231-633/019-000	3	231-633/018-000
4	231-634	4	231-634/019-000	4	231-634/018-000
5	231-635	5	231-635/019-000	5	231-635/018-000
:	:	:	:	:	:
12	231-642	12	231-642/019-000	12	231-642/018-000
:	:	:	:	:	:
21	231-651	21	231-651/019-000	21	231-651/018-000
22	231-652	22	231-652/019-000	22	231-652/018-000
23	231-653	23	231-653/019-000	23	231-653/018-000
24	231-654	24	231-654/019-000	24	231-654/018-000

Accessories

	Coding key, snap-on type, light grey 231-129		Coding key, snap-on type, light grey 231-129		Coding key, snap-on type, light grey 231-129
	Separator, for formation of groups, light grey 231-500		Separator, for formation of groups, light grey 231-500		Separator, for formation of groups, light grey 231-500
	Insulation stop, 5 pcs/strip 0.08 - 0.2 mm ² (white) 231-670 0.25 - 0.5 mm ² (light gr.) 231-671 0.75 - 1 mm ² (dark grey) 231-672  0.2 mm ² solid / 0.14 mm ² f-st		Tapping screw, B 2.2 x 9.5 209-147 fixing hole Ø 1.8 mm		Mounting adapter, for DIN 35 rail, grey 209-137 3 or more poles
	Marker strips, self-adhesive 1-12 (200 x) 210-331/0508-0103 13-24 (200 x) 210-331/0508-0104		Insulation stop, 5 pcs/strip Description and item Nos. on the left		Insulation stop, 5 pcs/strip Description and item Nos. on the left
	Marker strips, self-adhesive 1-12 (200 x) 210-331/0508-0103 13-24 (200 x) 210-331/0508-0104		Marker strips, self-adhesive 1-12 (200 x) 210-331/0508-0103 13-24 (200 x) 210-331/0508-0104		Marker strips, self-adhesive 1-12 (200 x) 210-331/0508-0103 13-24 (200 x) 210-331/0508-0104

Dimensions (in mm) A = (No. of poles x pin spacing) + 3.2 mm B = A - 1.7 mm C = A - 1.2 mm D = A - 0.2 mm E = D + 5.8 mm F = D + 11.8 mm

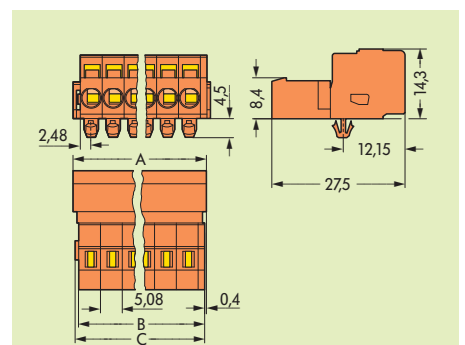
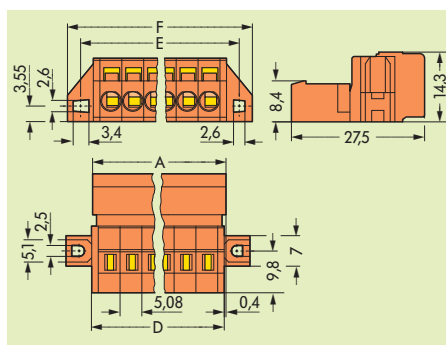
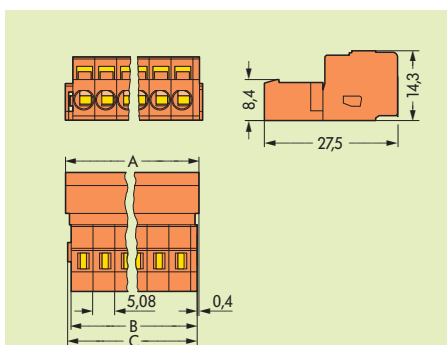

* Approvals with corresponding ratings see pages 12.3 ff.