

Model produktu	Z-56
Format:	A4
Materiál:	Polystyrene (PS)
Skála:	1:1
Tolerancia:	+/- 0.1

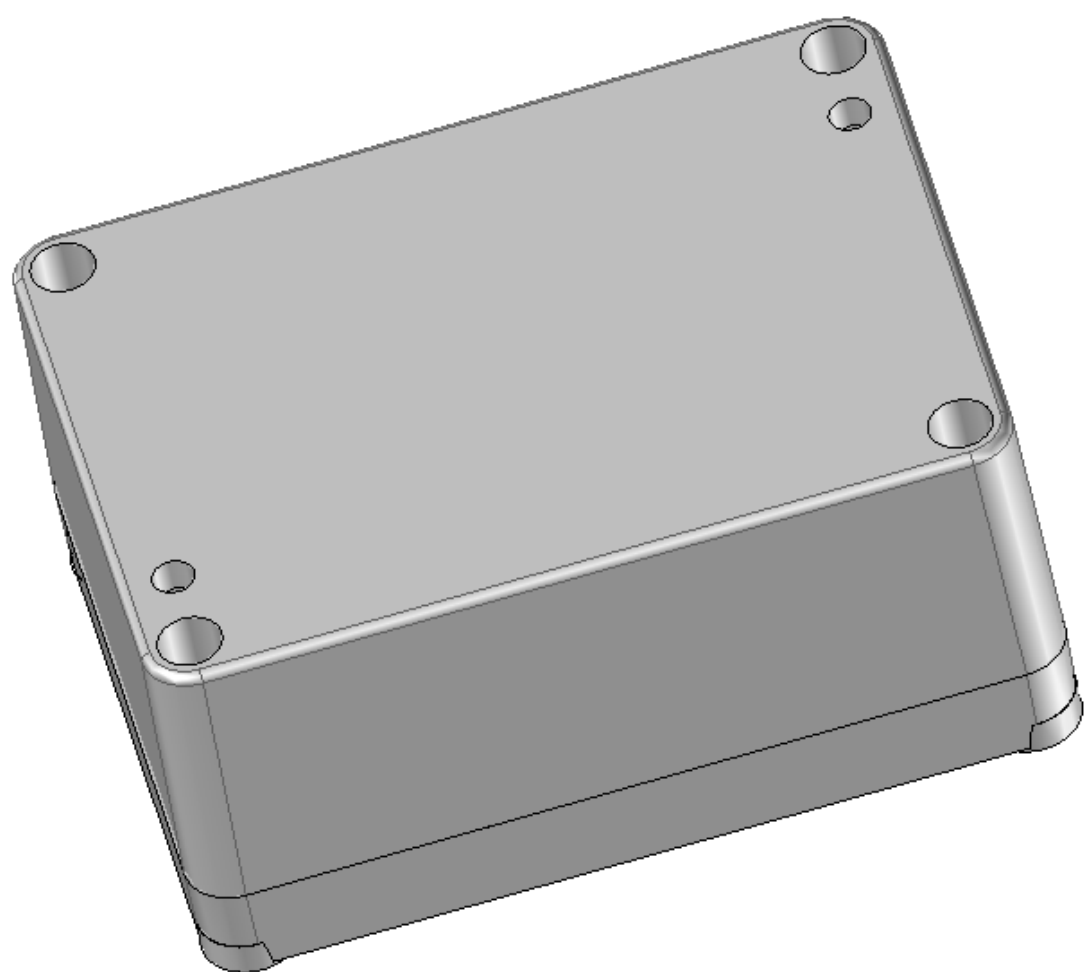

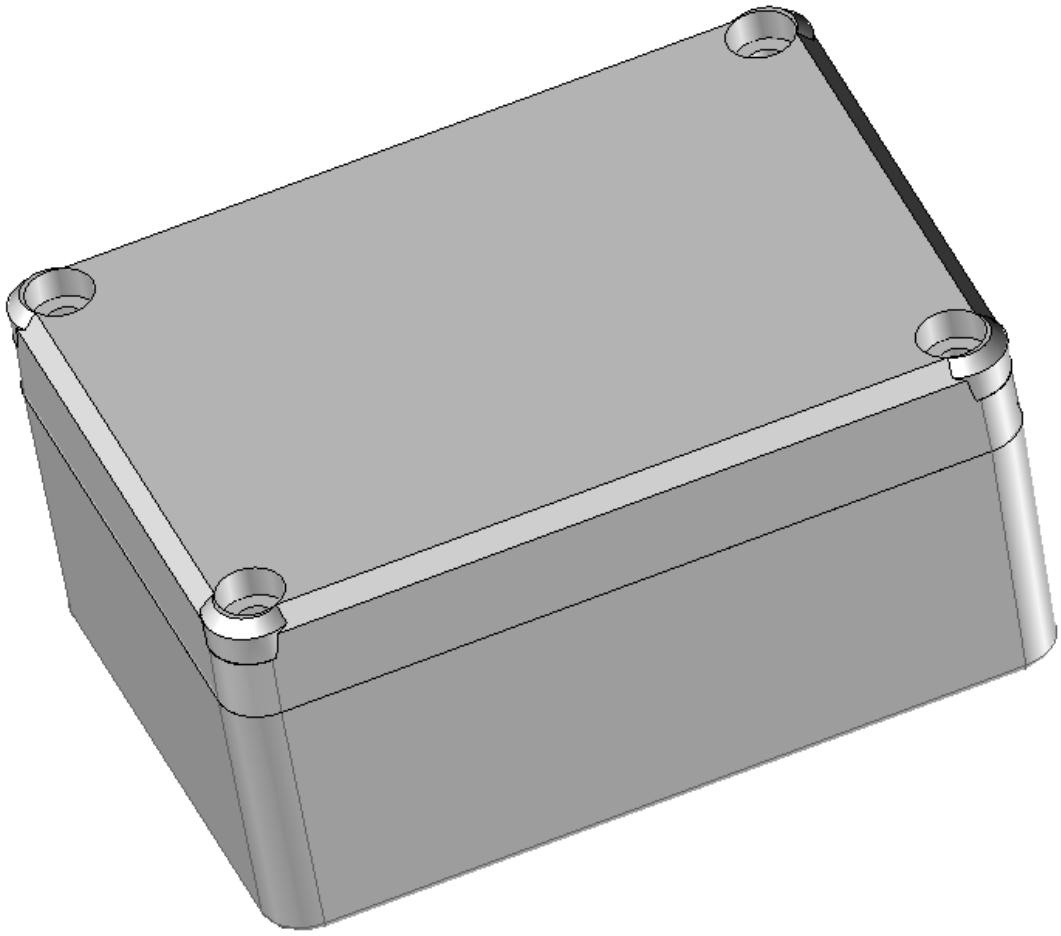

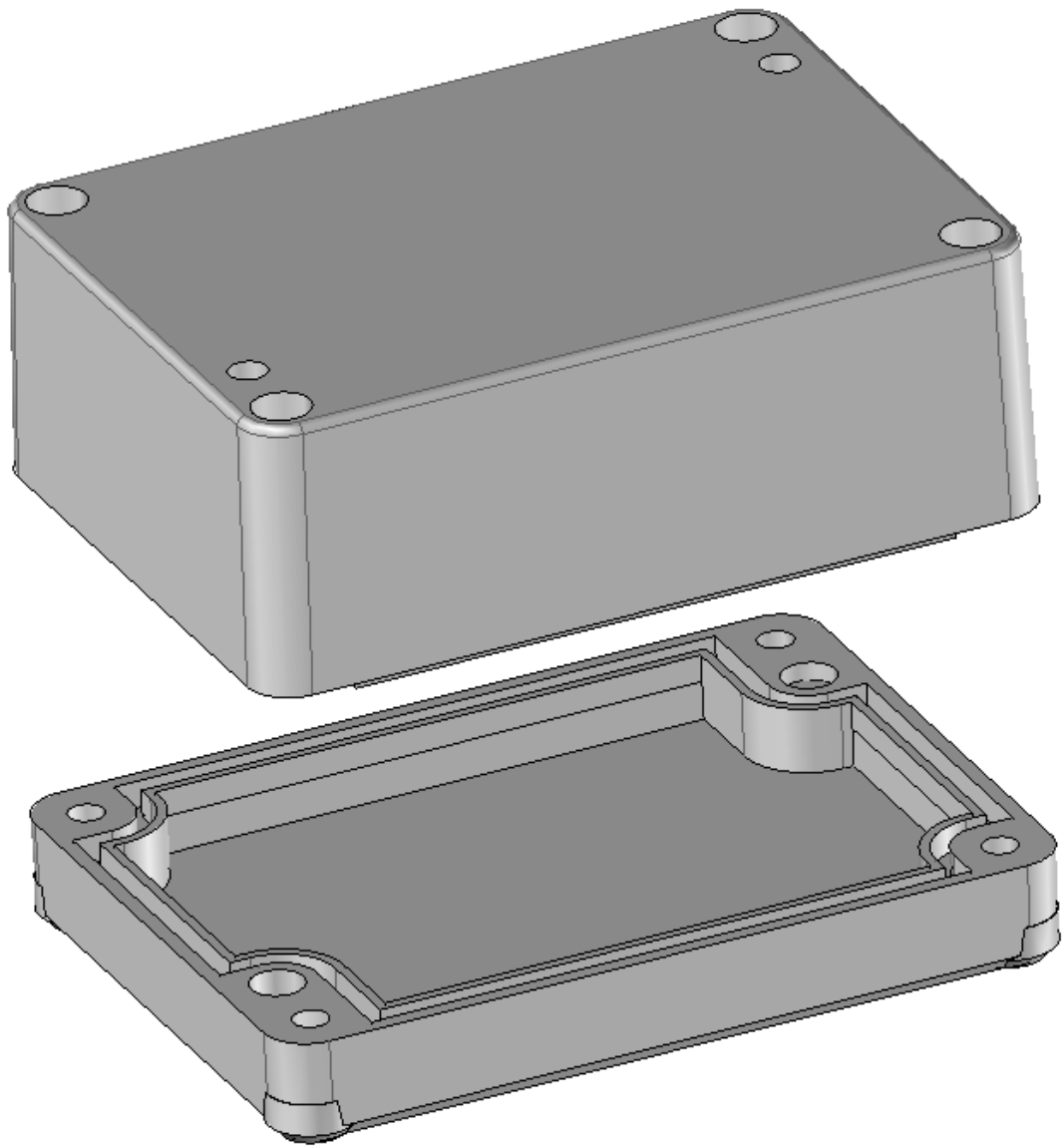

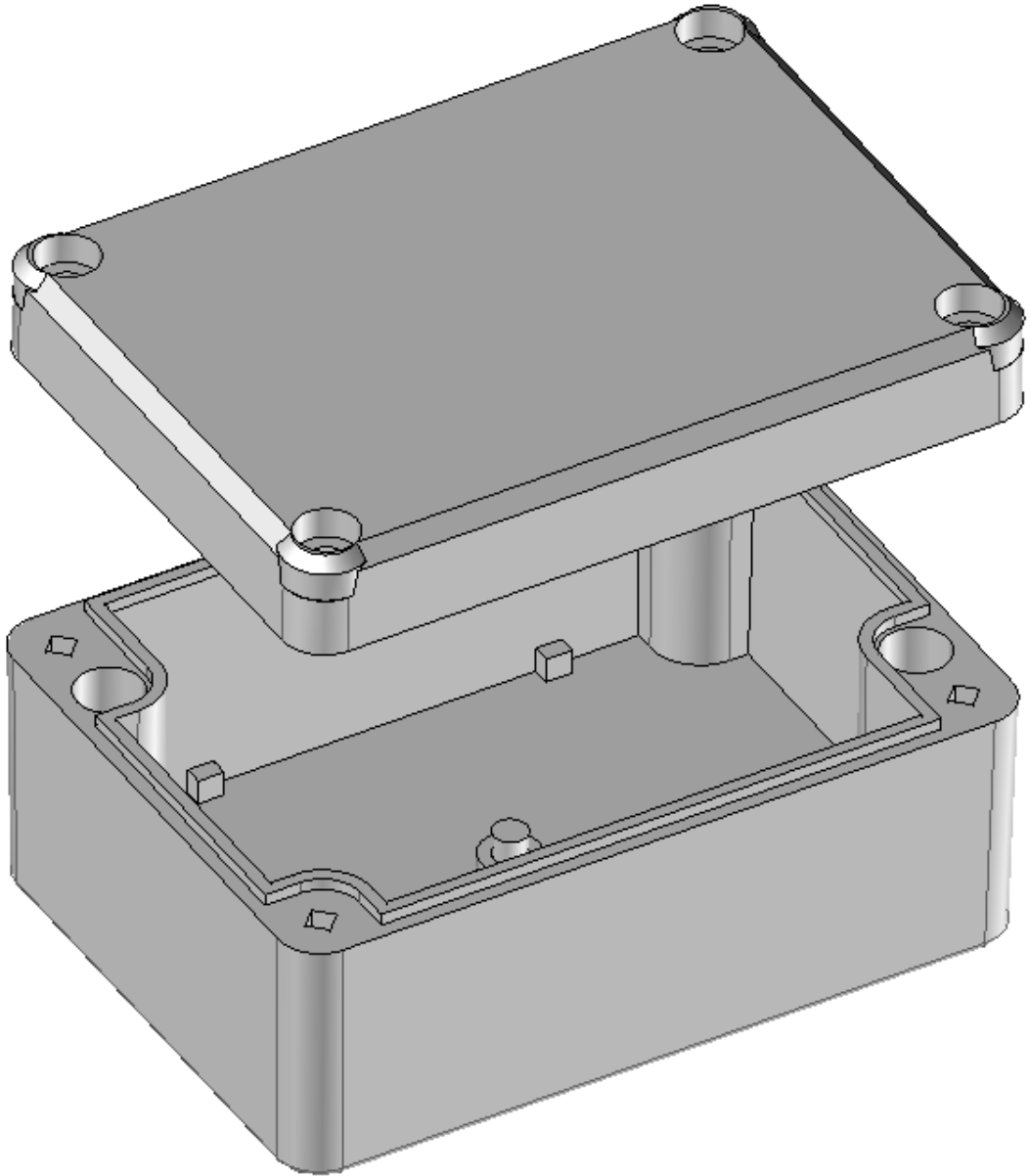

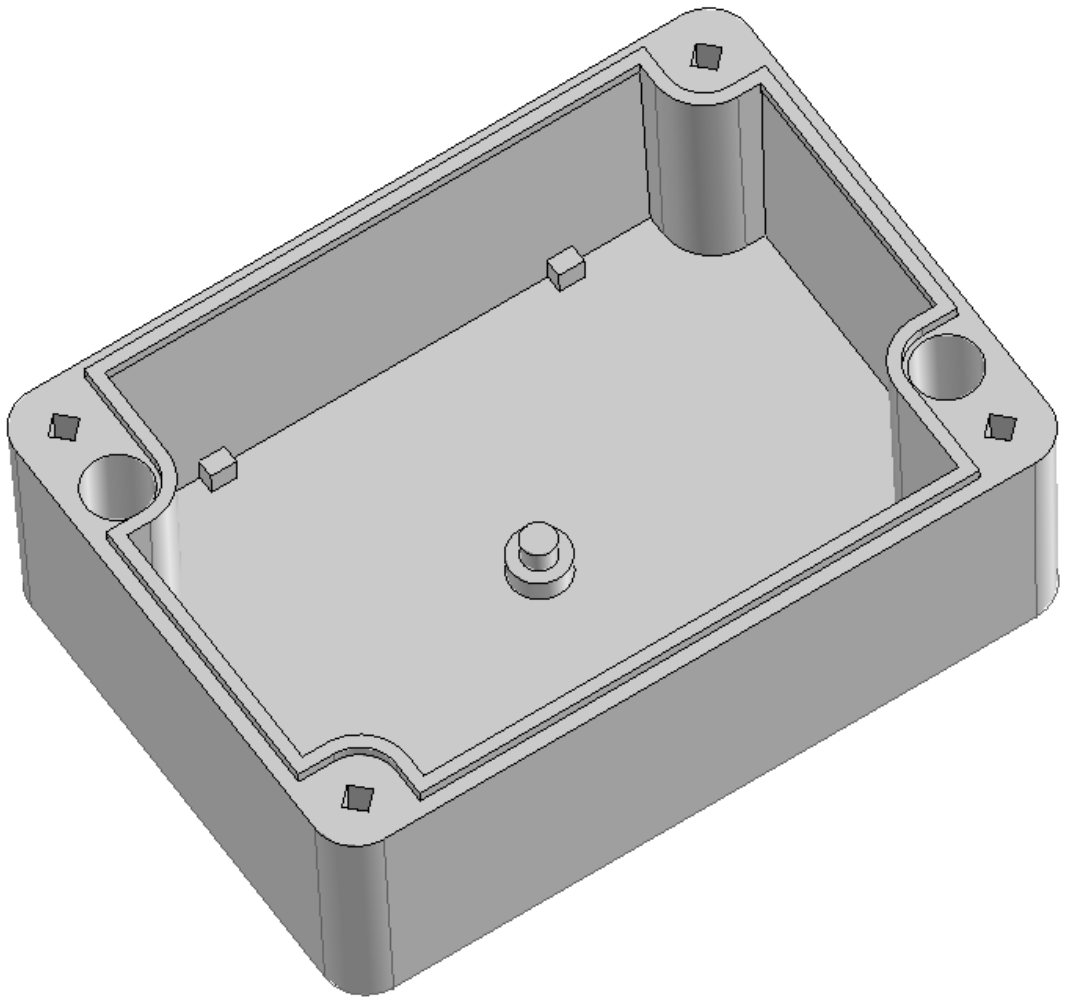

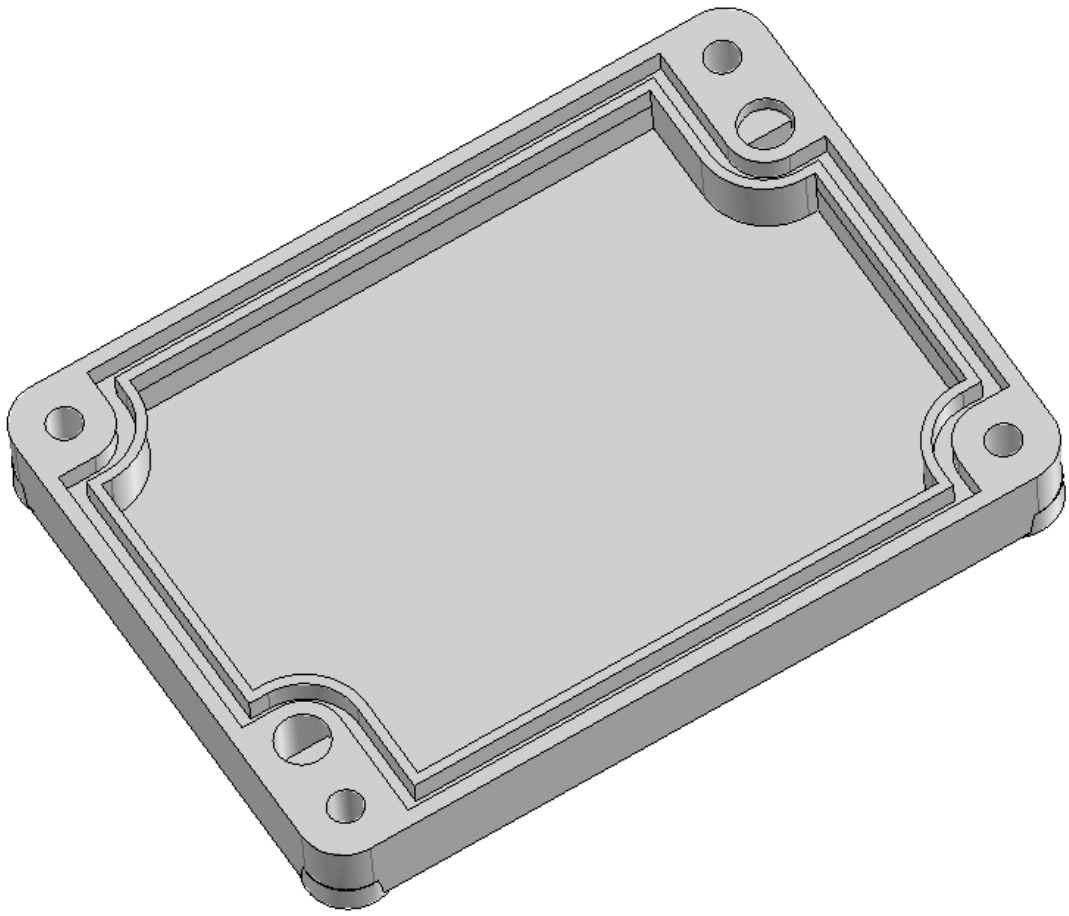

A - A

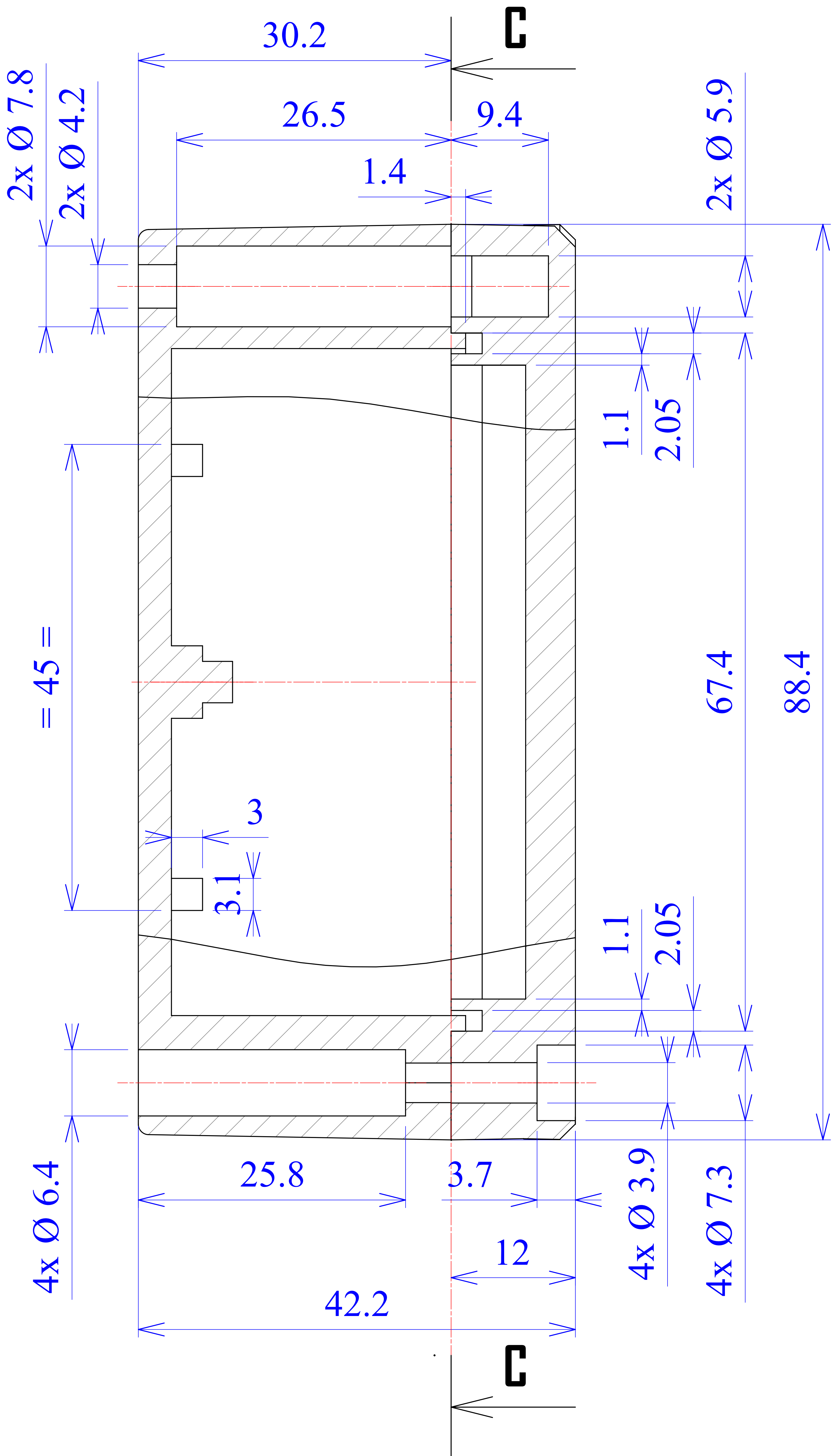

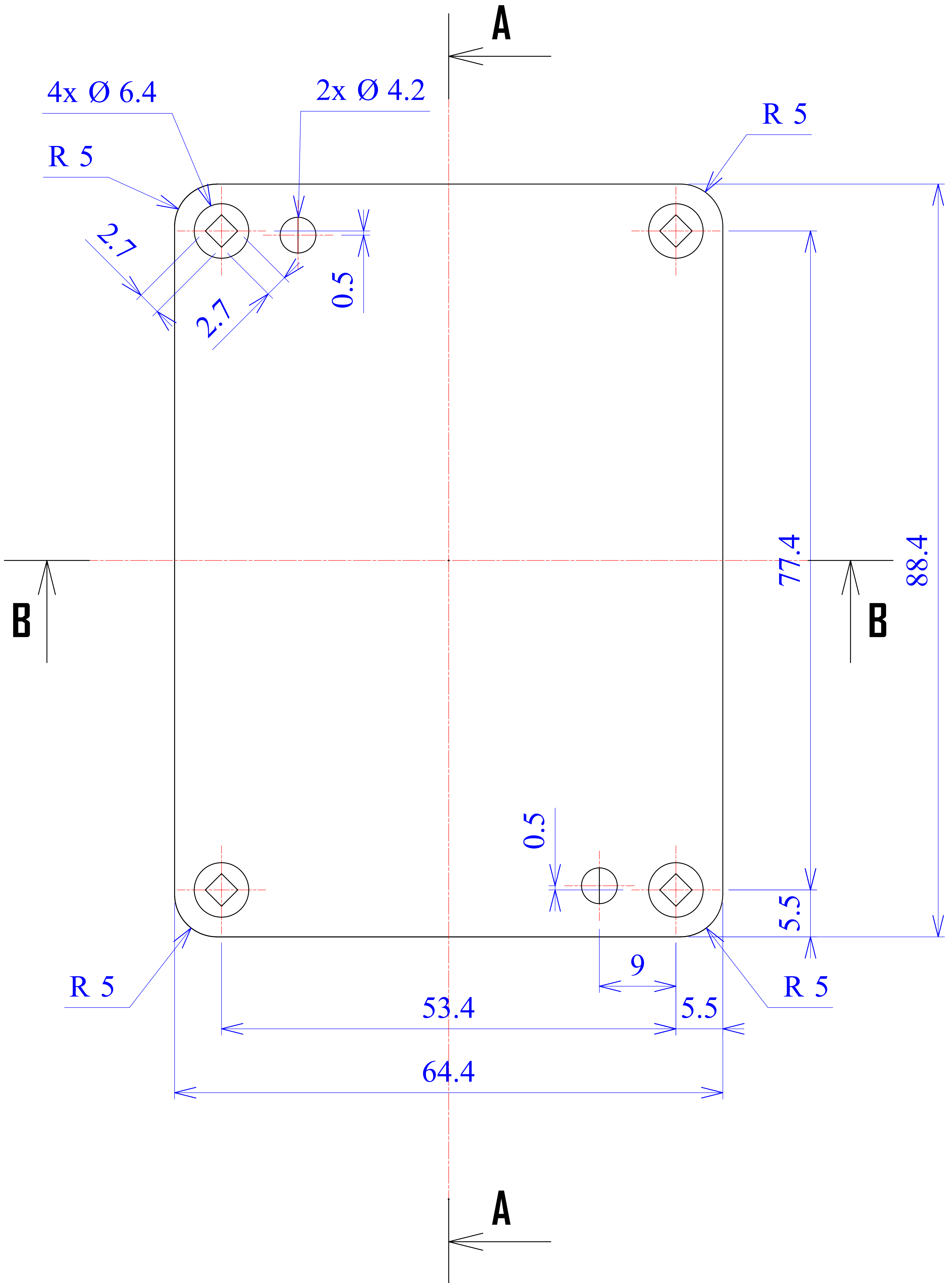

B - B

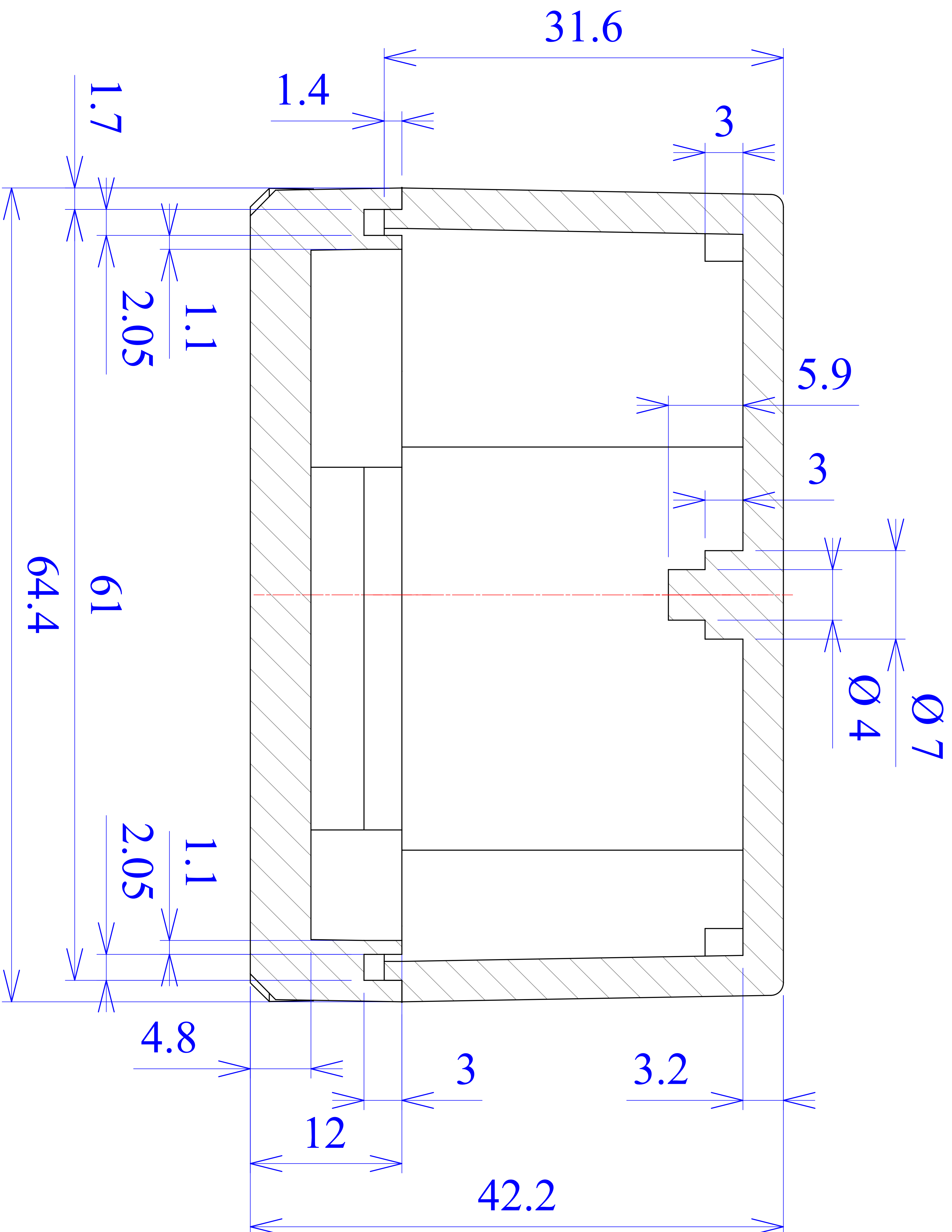

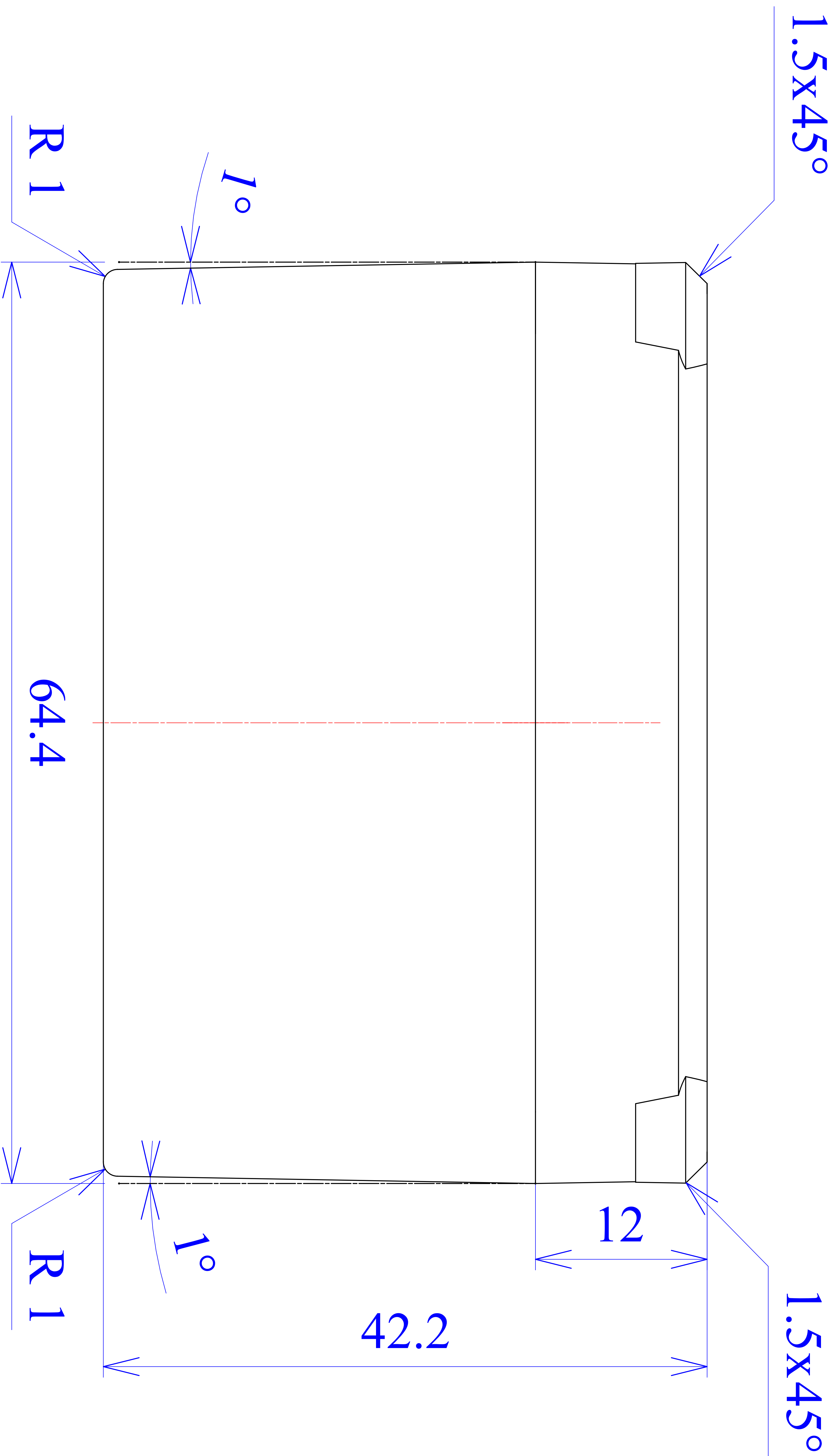

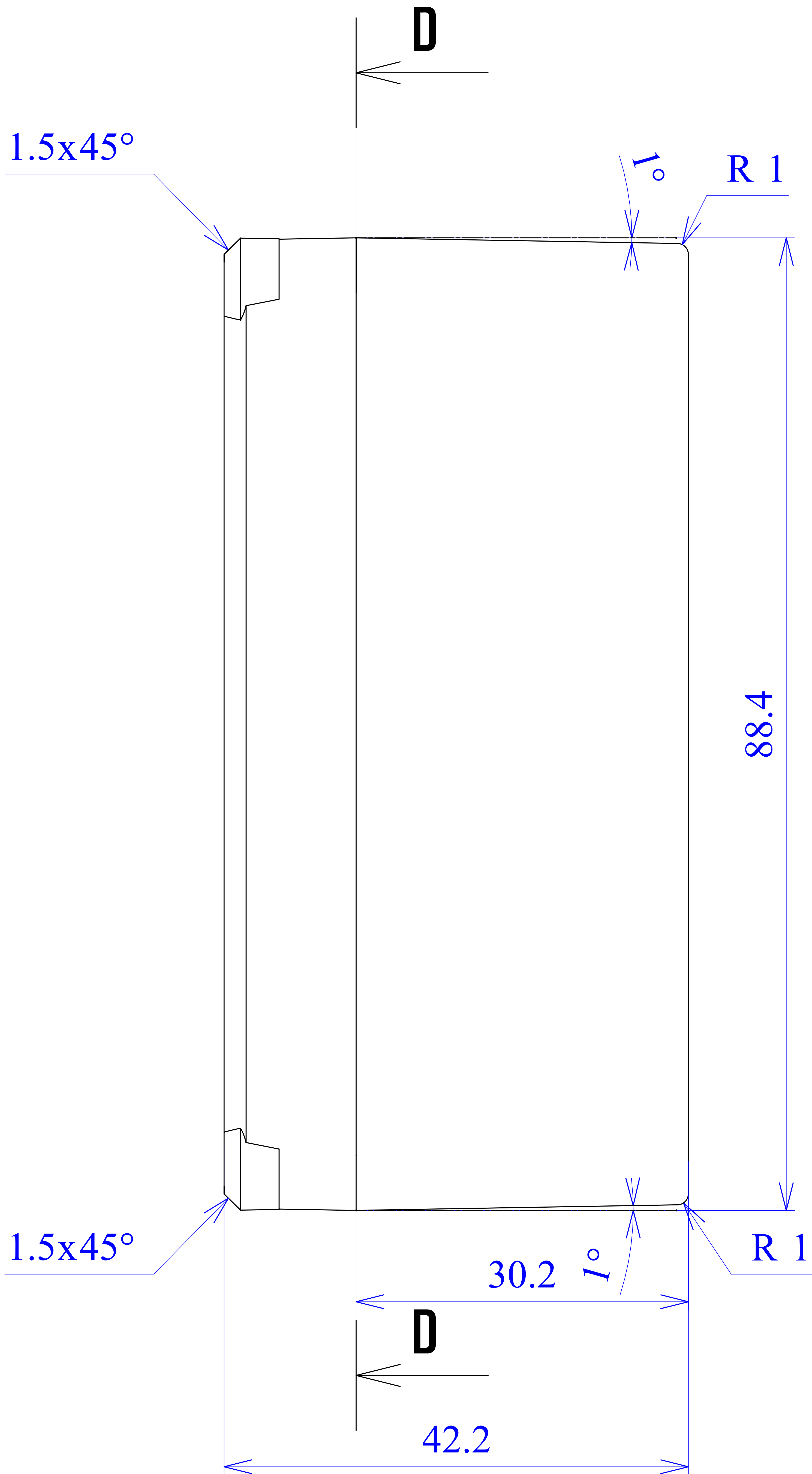

4x Ø 3.9

4x Ø 7.3

2.7

2.7

77.4

88.4

53.4

5.5

5.5

64.4

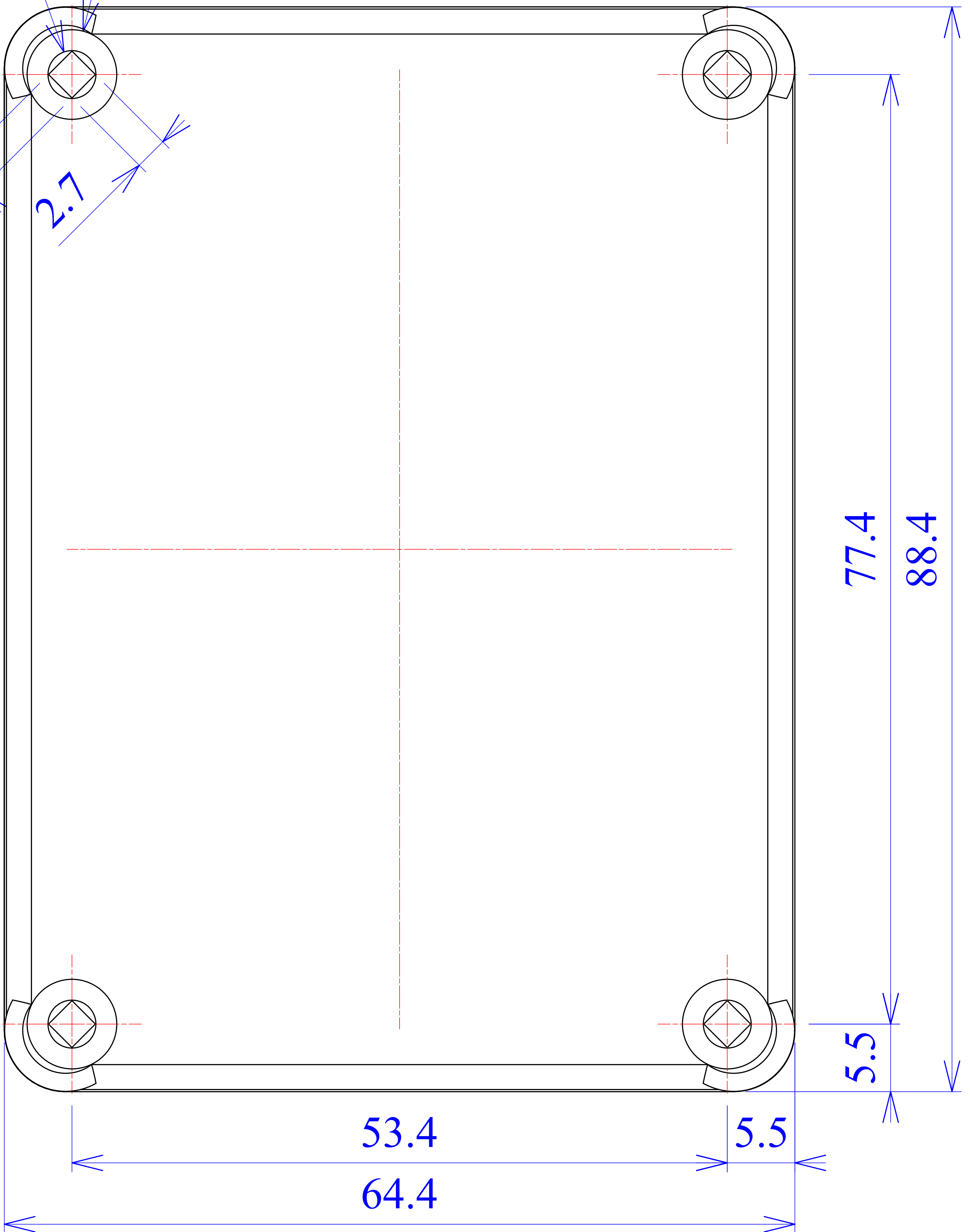

C - C

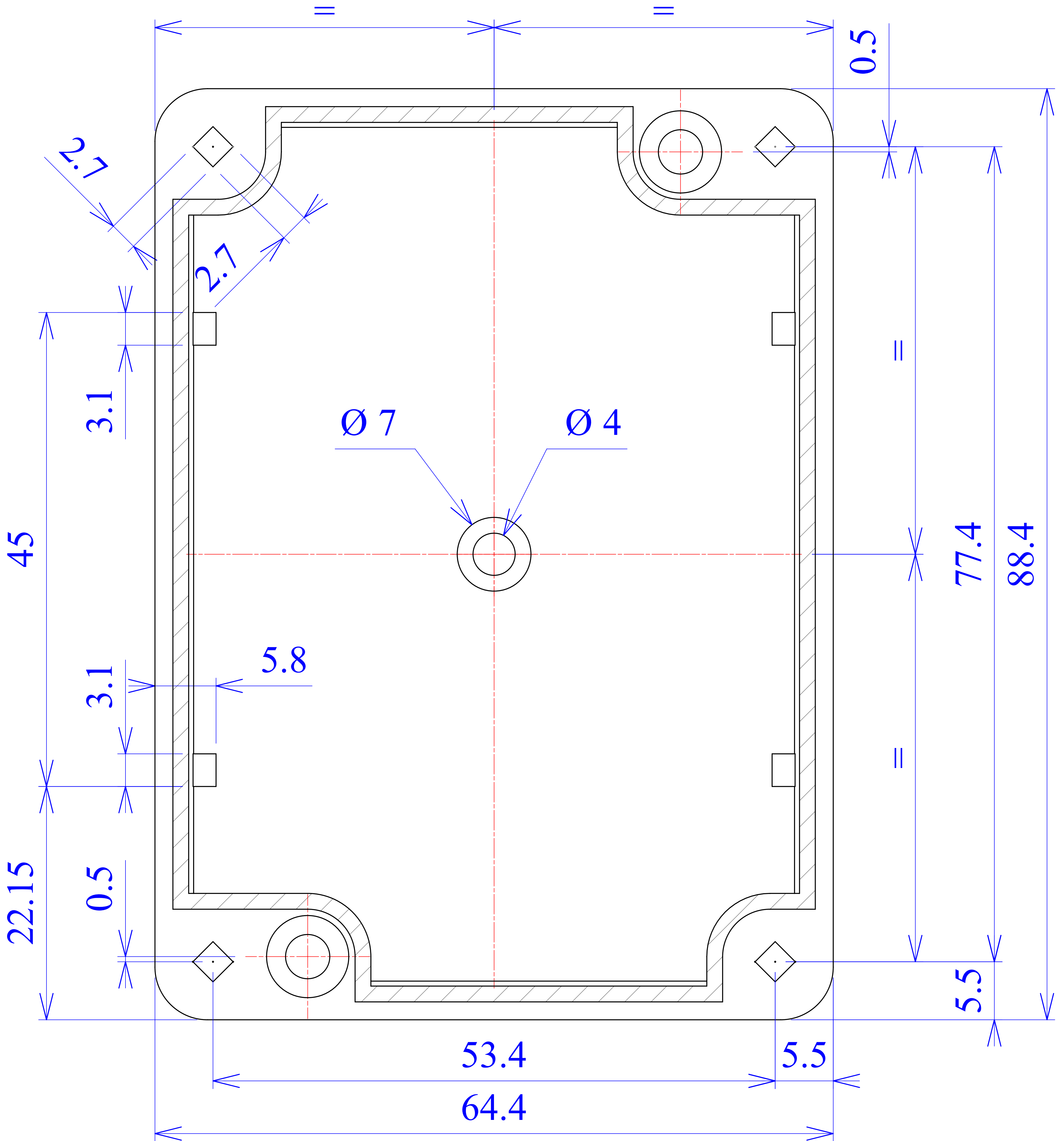

D - D

