

## ITV-GECWV407M User Manual

# CMOS TYPE CAMERA

### ◆ Application

The ITV-GECWV407M JPEG compression module performs as a video camera or a JPEG compressed still camera and can be fixed into all kinds of system. For example: remote monitoring, vehicle monitoring, visible the doorbell, camera phones, digital image records, industry control, access control, etc. Users can send out a snapshot command from the host in order to capture a full resolution single-frame still picture. The picture is then compressed by the JPEG engine and transferred to the host.

### ◆ Feature

1. Small size: 28mm x 20mm (L x W).
2. 0.3M CMOS ensor, VGA resolution, down sample to QVGA.
3. Video-out: VGA & 60fps, optional.
4. Low power consumption, 3.3V operation.
5. UART interface support up to 115.2Kbps.
6. Built-in JPEG CODE.
7. Built-in lens, optional.

### ◆ Outline

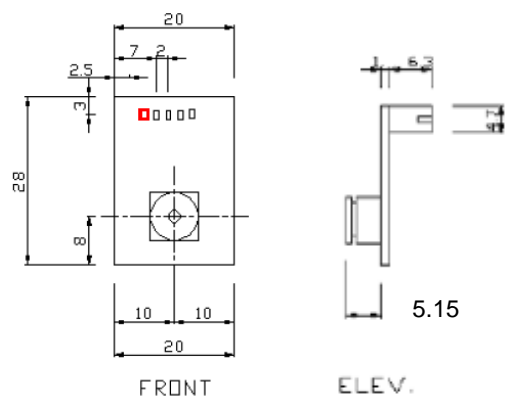
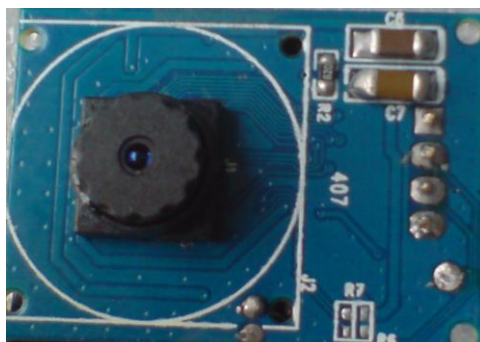

◆ Block Diagram

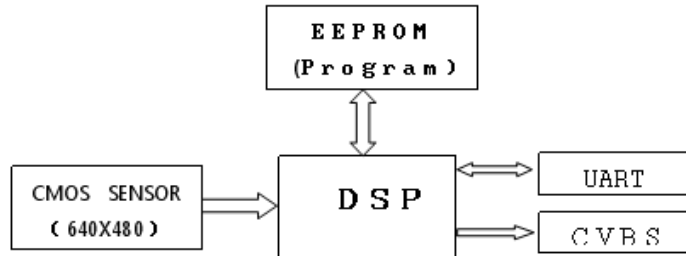

◆ Board Layout

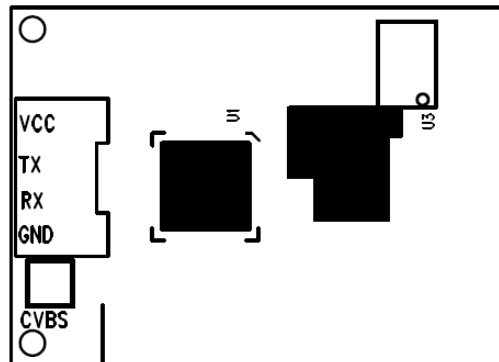

◆ Pin Function

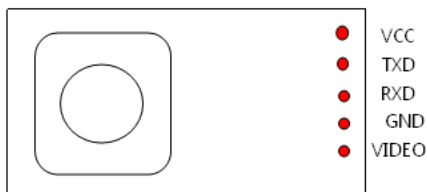

PIN	Description
VCC	Power 3.3VDC
TXD	Data Transmit(3.3V)
RXD	Data Receive (3.3V)
GND	Power Ground
VIDEO	1V p-p

\*The default socket is 4 pins, we will not assemble the fifth pin (Video out) unless user specify.

1.Lens Structure

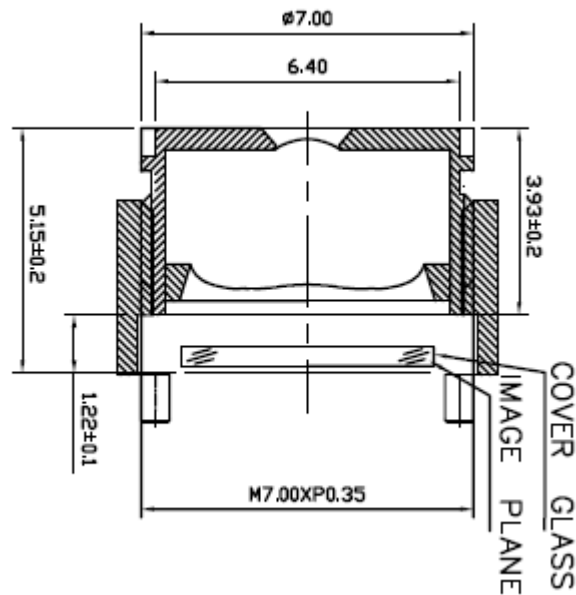

### ◆ Specification

Item	Specification	Remark
Pixel Size	PAL:628 x 582 / NTSC:510 x 492	NTSC default
Image Sensor	1/5"	CMOS sensor OV7740
Baud Rate	9.6Kbps~115.2Kbps	115.2Kbps default
Output	TTL	
Video Output	VGA & 60fps	1V <sub>p-p</sub>
Operating Voltage	3.3V±10%	
Working Current	110 mA	
Lens	Construction: 4P+IR filter	
	Effective Focal Length:3.27mm	
	F#:2.5	
	FOV:58°	
	Distortion <1.0%	
	Relative illumination: 60% Ø3.44	
Operating Temp.	-20°C ~ +60°C	

## User Manual

### 1. Serial Interface

#### 1.1 Baud Rate

The ITV-GECWV407M supports total 5 types of baud rate: 9,600bps, 19,200bps, 38,400bps, 57,600bps and 115,200bps. **Default** baud rate is **115,200bps**. In other words, host needs to use 115200bps at the first connection with ITV-GECWV407M. After the first connection, host can change the baud rate to other supported values.

#### 1.2 Single Byte Timing Diagram

A single byte RS-232 transmission consists of one start bit, 8-bit contents and one stop bit. A start bit is always 0, while a stop bit is always 1. LSB is sent out first and is right after the start bit.

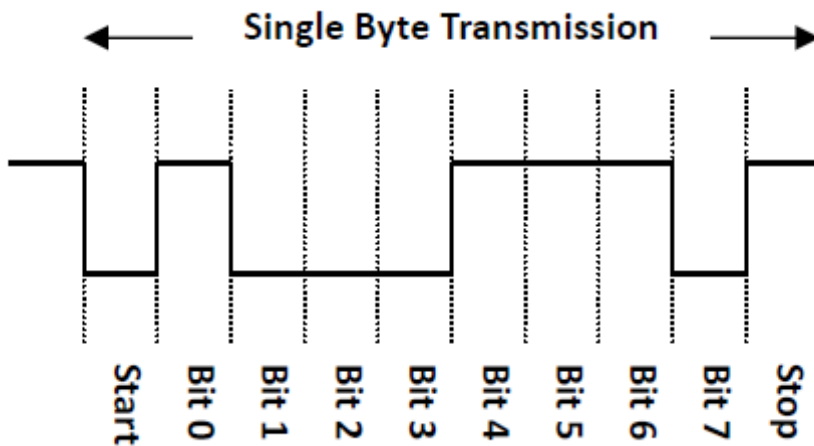

Figure 5 RS232 communications – single byte timing diagram

#### 1.3 Command Timing Diagram

A single command consists of 4 or more (depends on **data length**'s value) continuous single byte RS-232 transmissions. The following is an example of **GET VERSION** (56h, 00h, 11h, 00h) command.

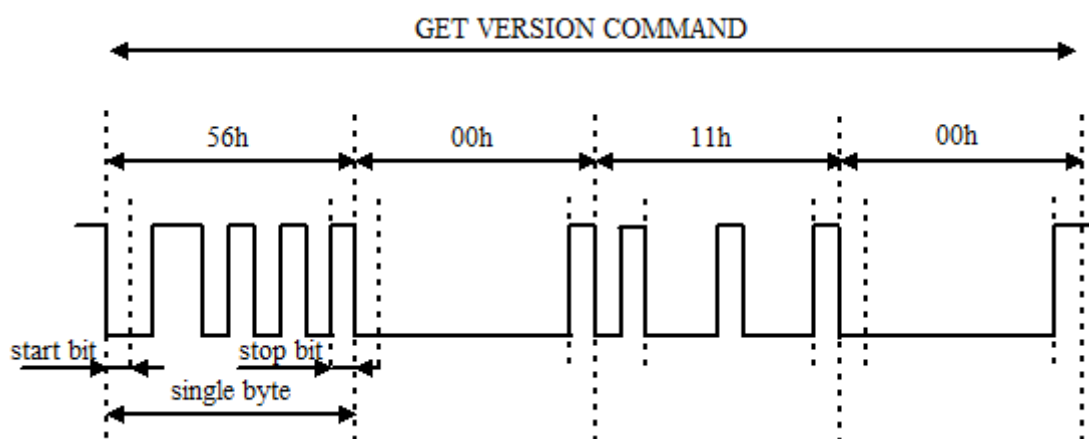

Figure 6 GET VERSION command timing diagram

### 1.4 Command summary

Command	Functions
GET VERSION	Get Firmware version information
SYSTEM RESET	System reset
FBUF CTRL	Control frame buffer
GET FBUF LEN	Get image lengths in frame buffer
READ FBUF	Read frame buffer
SET BAUDRATE	Set serial baud rate
SET SAMPLESIZE	Set image size(VGA/QVGA)
SET COMPRESSRATIO	Set image compressed rate
COM REPLY	Host will get reply command from JC409M-W01

Table 1 command summary

### 1.5 Command format

**Protocol sign(1byte) + Serial No.(1byte) + Command(1byte) + Data length(1byte) + Control data(nbytes)**

**Protocol sign:** This one byte field indicates the transmitting mode of the command.

Protocol sign	value	definitions
Sending command	56h	The command is sent from the host to ITV-GECWV407M
Replying command	76h	Command is received from ITV-GECWV407M to the host

Table 2 protocol sign

**Serial No.:** Now this one byte field is invariably set to 0.

**Command:** This one byte field indicates the command function. About the detail, please refer to Table 3 command set.

**Data length:** This one byte field specifies the total length in bytes of **control data** by which is followed.

**Control data:** The data of this field is only meaningful when **Data length** is not equal to 0. This data depends on the different commands. About the details, please refer to the following sections.

**1.6 Command protocol**

Command name	Protocol sign	Serial No.	Command value	Data length	Control data
GET VERSION	56h	00h	11h	00h	Don't care
SYSTEM RESET	56h	00h	26h	00h	Don't care
FBUF CTRL	56h	00h	36h	01h	To know data vaule of this field, please refer to the following sections
GET FBUF LEN	56h	00h	34h	01h	
READ FBUF	56h	00h	32h	0Ch	
SET BAUDRATE	56h	00h	31h	06h	To know data vaule of this field, please refer to the following sections
SET SAMPLESIZE	56h	00h	31h	05h	
SET COMPRESSRATIO	56h	00h	31h	05h	
COM REPLY	76h	00h	Depends on the different sending commands. To know data value of this field, please refer to the following sections		

Table 3 Command set

**1.6.1 GET VERSION Command**

The GET VERSION command is used to get version information of the firmware running in ITV-GECWV407M.

1.6.1.1 Command format: **56 00 11 00**

1.6.1.2 COM REPLY: **76 00 11 00 0B 56 43 30 37 30 36 20 31 2E 30 30** ("VC0706 1.00")

6.6.1.3 Communication protocol:

To get the firmware version, please follow the below operations:

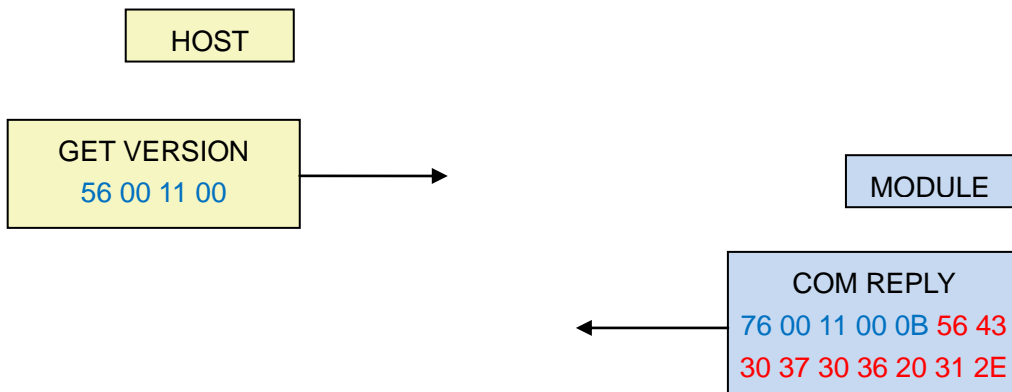

### 1.6.2 SYSTEM RESET Command

The SYSTEM RESET command is issued by the host in the following case:

- ✧ There is always no reply after several commands were sent by host.

1.6.2.1 Command format: 56 00 26 00

1.6.2.2 COM REPLY: 76 00 26 00 00

1.6.2.3 Communication protocol:

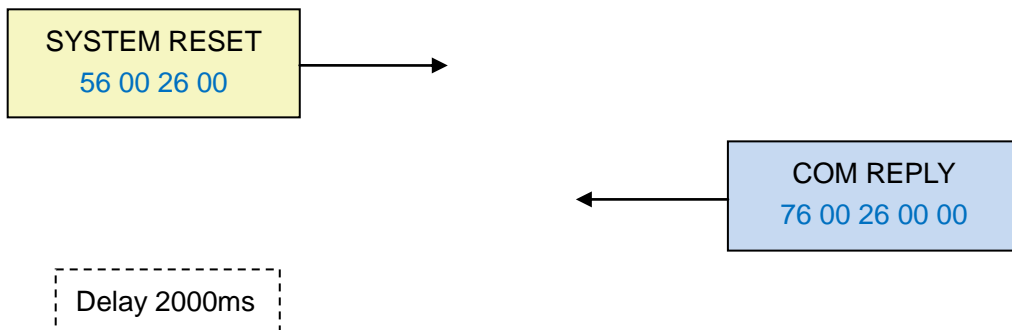

When the host has received the correct COM REPLY [76 00 26 00 00], after about ten milliseconds, ITV-GECWV407M is going to restart. About 2s later, JC409M-W01 works normally as usual.

### 1.6.3 FBUF CTRL command

The FBUF CTRL command is used to stop current frame image data update in frame buffer in order to get current frame still image.

1.6.3.1 Command format: 56 00 36 01 P1 where P1 (one byte) is the control parameter of video frame buffer. Table 4 lists out the definition of P1.

Frame control parameter (P1)	Definition
0	Stop frame buffer data update at current frame
3	Resume normal video state

Table 4 Frame control parameter

1.6.3.2 COM REPLY: 76 00 36 00 00

1.6.3.3 Communication protocol:

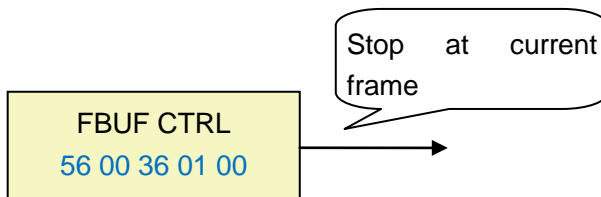

1.6.4 GET FBUF LEN command



The GET FBUF LEN command is used to get size of current frame still image in frame buffer.

1.6.4.1 Command format: 56 00 34 01 00

1.6.4.2 COM REPLY: 76 00 34 00 04 P2 where P2 (4 bytes) is the size of image data which host wants to get.

1.6.4.3 Communication protocol:

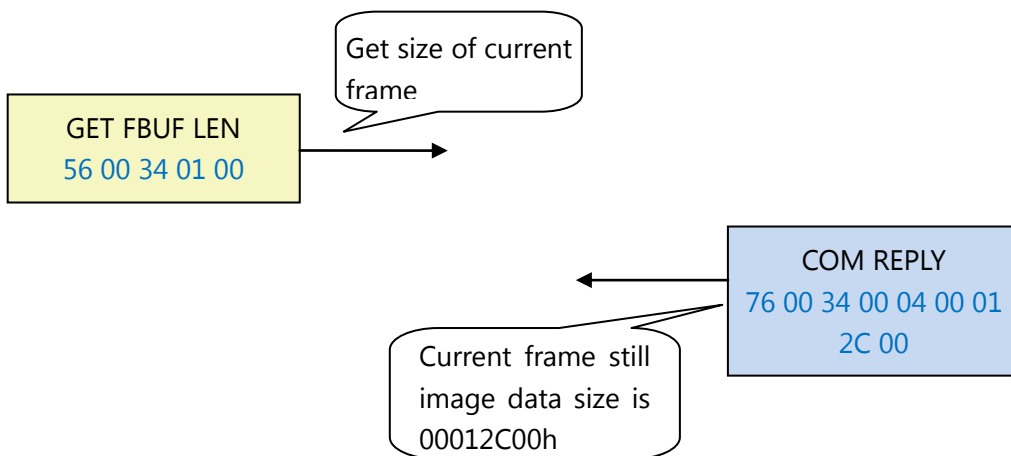

1.6.5 READ FBUF command



The host sends this command to get the image data from frame buffer.

1.6.5.1 Command format: `56 00 32 0C 00 0A 00 00 00 00 P3 P4` where P3 (4 bytes) informs JC409M-W01 that how many bytes of data the host is going to read. It must be multiple of 4. P4 (2 bytes) represents the delay time between the command and data received from COM REPLY (see 6.6.5.2). The time unit is 0.01 millisecond. For example: P4 = 10 00, delay time is 10 milliseconds.

1.6.5.2 COM REPLY: `76 00 32 00 00 P5 76 00 32 00 00` where P5 (n bytes) is the image data which host wants to get. n is equal to P3 in this case.

1.6.5.3 Communication protocol:

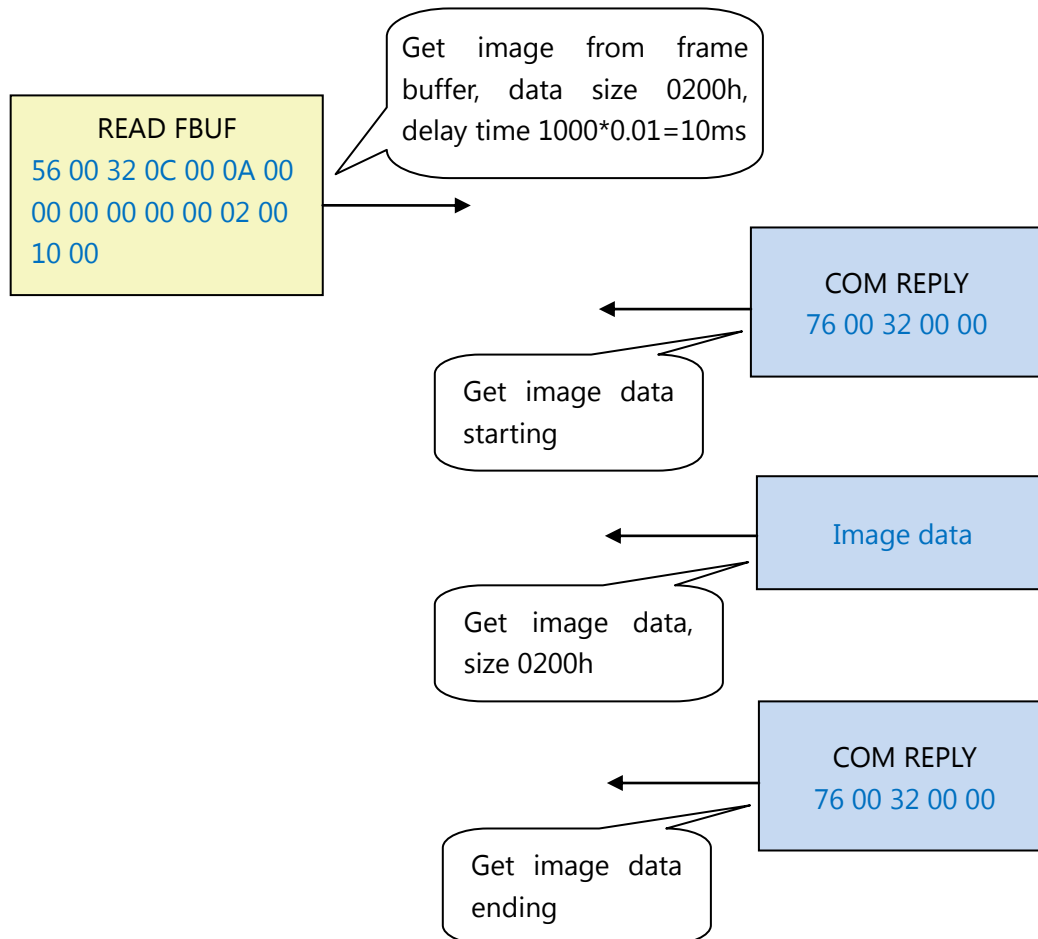

**Note: Before sending this command, users should issue GET FBUF LEN command to get the image size first.**

**1.6.6 SET BAUDRATE command**

The host issues this command to set the UART baud rate.

1.6.6.1 Command format: **56 00 31 06 04 02 00 08 P6** where P6 (2 bytes) is the configuration value of UART baud rate. The relationship between configuration value and baud rate is shown in Table 5.

Baud rate(bps)	Configuration value
9600	0xAEC8
19200	0x56E4
38400	0x2AF2
57600	0x1C4C
115200	0x0DA6 (default)

Table 5 Baud rate relationship

1.6.6.2 COM REPLY: **76 00 31 00 00**

1.6.6.3 Communication protocol:

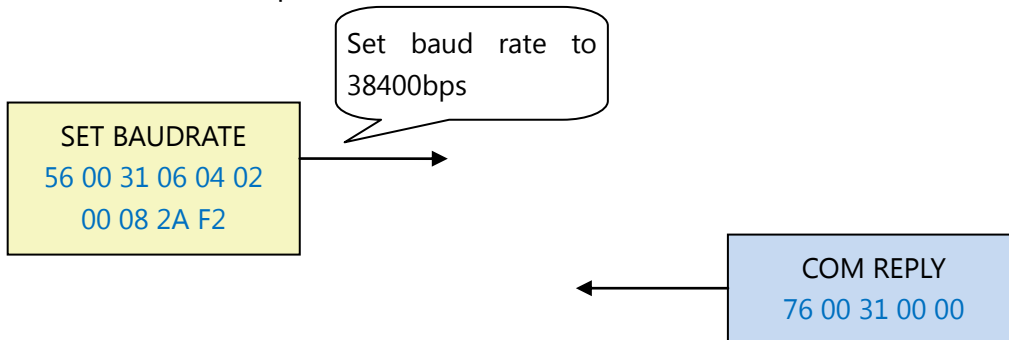

**1.6.7 SET SAMPLESIZE command**

The host issues this command to set the sample size of image (image resolution).

1.6.7.1 Command format: **56 00 31 05 04 01 00 19 P7** where P7 (1 byte) is the configuration value of image sample size. The relationship between configuration value and image resolution is shown in Table 6.

Image resolution	Configuration value
VGA	0x00 (default)
QVGA	0x11
QQVGA	0x22

Table 6 image resolution size relationship

1.6.7.2 COM REPLY: 76 00 31 00 00

1.6.7.3 Communication protocol:

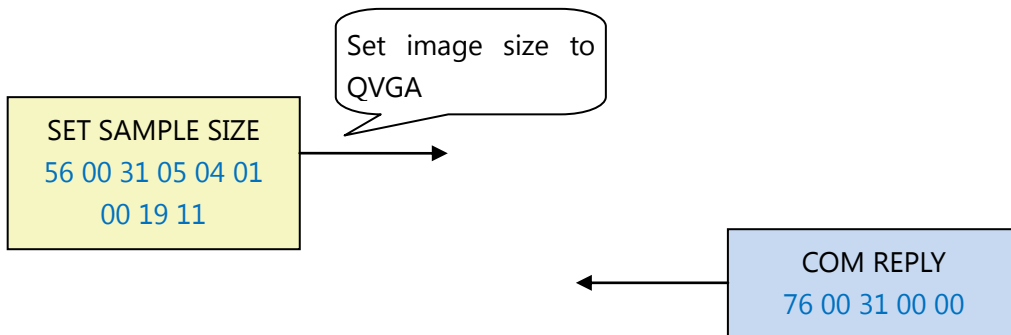

### 1.6.8 SET COMPRESSRATIO command

The host issues this command to set compressing rate of the image.

1.6.8.1 Command format: 56 00 31 05 04 01 00 1A P8 where P8 (1 byte) is the configuration value of image compression ratio. This compression ratio value is ranged from 0x00 to 0xFF. The bigger the value is, the higher the compression ratio. Default compression ratio is **0x35**.

1.6.8.2 COM REPLY: 76 00 31 00 00

1.6.8.3 Communication protocol:

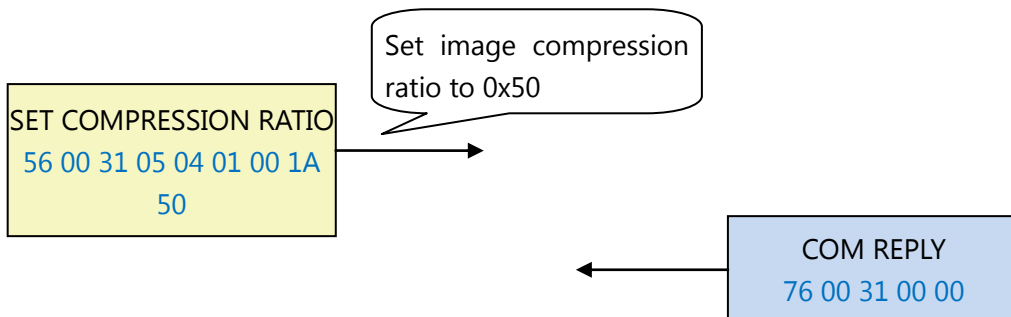

### **1.6.8 COM REPLY command**

The COM REPLY is a UART command which is sent from ITV-GECWV407M in order to inform the host whether the command which was just sent is executed well or in order to transmit the data which the host wants to get. About all cases of COM REPLY command please refer to the above commands sections.

**NOTE: When the host issues SET BAUDRATE command, SET SAMPLE SIZE command or SET COMPRESS RATIO command, the system needs to restart to take effect. These parameters are stored into camera module's built-in EEPROM. So next time module boots up, these parameters still work.**

## Appendix A – Flow diagram for getting an image

Below is the flow diagram for getting one or more images:

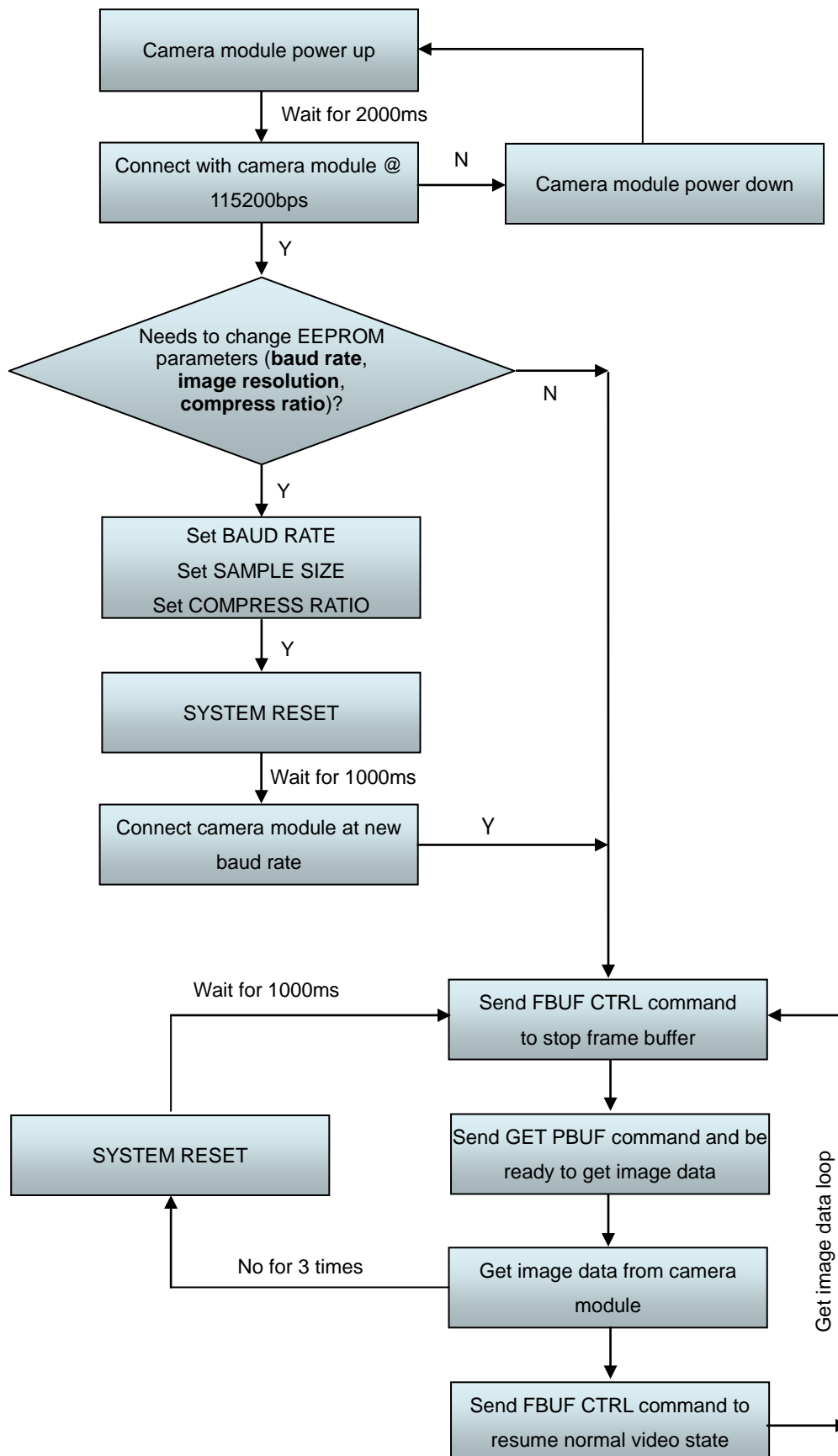

**Appendix B: Communication example for getting an image**

Below is the example for how to get a QVGA image by UART @ baud rate 57600bps and higher compression ratio.

