

THIS DOCUMENT IS THE PROPERTY OF
KEYSTONE ELECTRONICS CORP. AND
SHALL NOT BE REPRODUCED, DISTRIBUTED
OR USED AS A BASIS FOR MANUFACTURE
WITHOUT PRIOR WRITTEN PERMISSION
FROM KEYSTONE ELECTRONICS CORP.

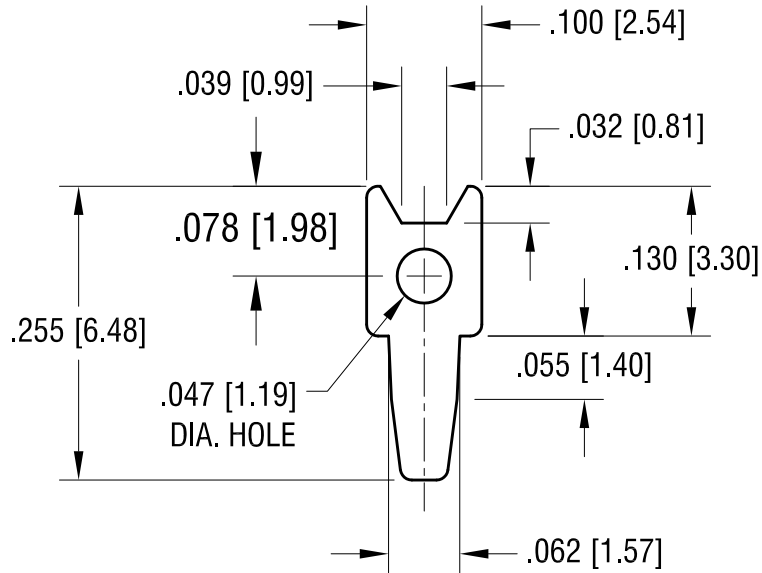
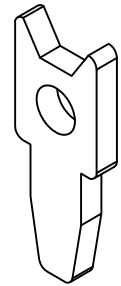

KEYSTONE ELECTRONICS CORP.

www.keyelco.com • ASTORIA, N.Y. 11105-2017 • Tel (718) 956-8900

PART NAME		PC TEST POINT TERMINAL	
MATERIAL		.025 [0.63] TH'K BRASS	
FINISH		DRN BY	DATE
MATTE TIN PLATE		BOONE	6.8.98
		APP'D	SCALE
		LN	6X
TOLERANCES	INCH [MM]	CODE	DWG NO.
DECIMAL	± .005 [± 0.15]	C/M	1032
ANGULAR	± 1°		
UNLESS OTHERWISE SPECIFIED			

6.30.09	CHANGE AS PER ECN 09-091	A
DATE	DESCRIPTION	REV.