

1 2 3 4 5 6

A

B

C

D

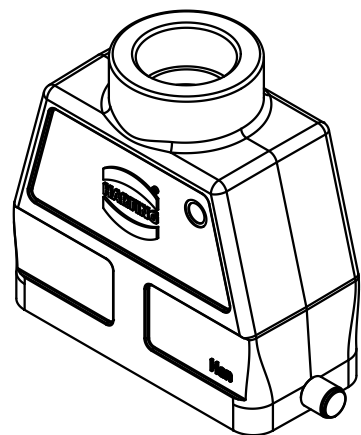
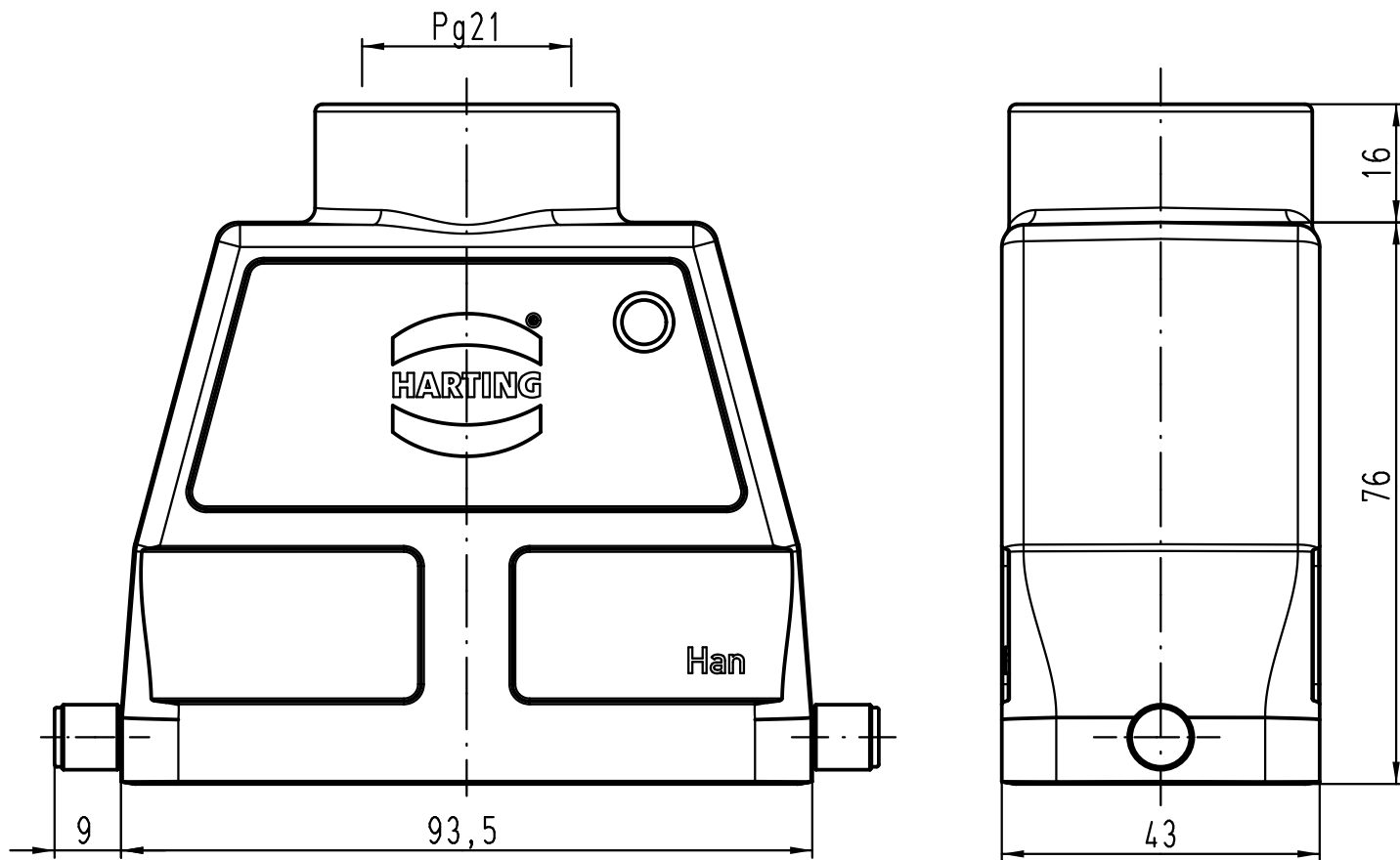

All Dimensions in mm Original Size DIN A 4		Techn. Character.			Nicht tolerierte Maße! Free size tolerances	
			Dat.	Name	Maßstab/Scale 1:1	Han 16B-gg-R-21 Gehäuse/hood
		Detail.	11.04.11	Ho		
		Insp.		Be		
		Stand.				
A			HARTING Electric GmbH & Co. KG			TB 09 30 016 0440
Mod.	Dat.	Name	D-32339 Espelkamp			
Sub. TB 09 30 016 0440 v. 22.10.01						Blatt/page