

THIS DOCUMENT IS THE PROPERTY OF
KEYSTONE ELECTRONICS CORP. AND
SHALL NOT BE REPRODUCED, DISTRIBUTED
OR USED AS A BASIS FOR MANUFACTURE
WITHOUT PRIOR WRITTEN PERMISSION
FROM KEYSTONE ELECTRONICS CORP.

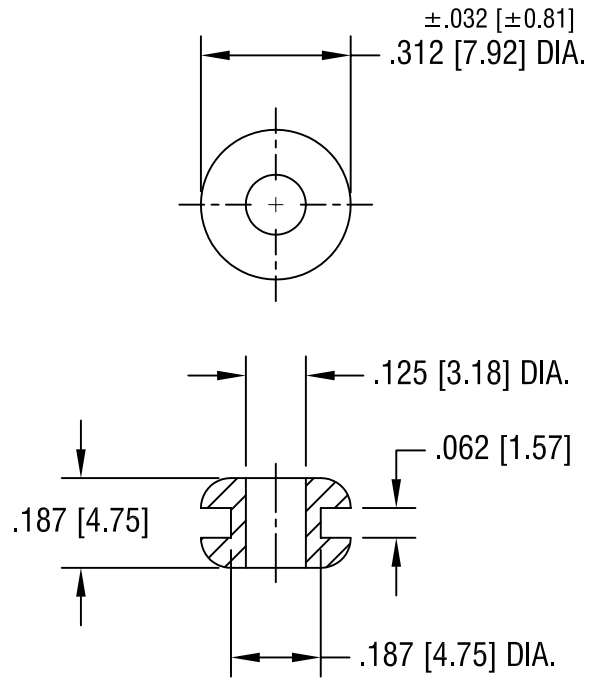

KEYSTONE ELECTRONICS CORP.			
ASTORIA, N.Y. 11105-2017			
PART NAME		RUBBER GROMMET	
MATERIAL		BUNA S	
FINISH		DRN BY	DATE
-		BOONE	9.16.96
		APPD	SCALE
			2.5X
TOLERANCES		INCH	[MM]
DECIMAL		$\pm .020$	$[\pm 0.50]$
ANGULAR		$\pm 1^\circ$	
UNLESS OTHERWISE SPECIFIED		CODE	DWG NO.
		C/M	730

DATE	DESCRIPTION	REV.